

PRIMUS





OUR PHILOSOPHY





EFFICIENCY & LONGEVITY All our products are crafted to withstand all types of conditions, ensuring reliability for generations to come. Built with reparability in mind, spare parts are readily available, prolonging the lifespan of each item. We not only prioritize durability but also operational reliability, allowing for quick and efficient cooking while minimizing environmental impact. By conserving fuel and resources, Primus products aim to facilitate outdoor adventures with minimal ecological footprint, reflecting a commitment to sustainability and efficiency. projects via First Climate. Since last year we are also offsetting the emissions from our Powerfuel, making all our fuel carbon offset.

For our emissions 2022 we have supported a project in Istanbul, Turkey developing and constructing facilities converting landfill gases from two landfills into electric energy. The project is Gold Standard certified (GS ID 707).



INNOVATION TEST LAB At Primus' test lab, our dedicated team of engineers operates amidst an array of tools and equipment, creating an ideal environment for designing and testing prototypes under all types of conditions. Each product undergoes rigorous series of performance tests to ensure perfection before moving into production.

We make no compromises, and no details are left to chance. That's why each product must undergo inspection by three pairs of hands during assembly. As a final touch, our skilled assemblers ignite all stoves one final time before reaching your hands. These measures guarantee perfection and years of reliable use for many years of adventures.



MATERIAL We are dedicated to solid craftsmanship and small-scale production, prioritizing durability and sustainability over cost. Our products are crafted from carefully selected materials, ensuring longevity even in the harshest conditions. We opt for materials with extended lifespans, aiming to minimize our environmental footprint. When it comes time to retire a Primus stove, we ensure that its materials can be repurposed or recycled. Our aim is to design products that not only excel in performance but also contribute to a more sustainable future.



INNOVATED IN SWEDEN – Produced in Europe To ensure highest quality we keep our development in-house at our headquarters in Stockholm, Sweden. From design to thorough testing of prototypes until ready for production.

Since 1994, our Tartu factory in Estonia, strategically located near the Baltic, houses 30 skilled assemblers. This proximity ensures rigorous quality control and honors Europe's crafting heritage.

From initial concept to final production, each stage reflects precision and craftsmanship, setting Primus apart as a leader in outdoor cooking equipment.



EXPEDITION SERVICE For more than 130 years our products have been tested and trusted in the harshest of environments. We take great pride in ensuring all our products meet superior quality and that they will, with the proper maintenance, provide years and years of service. That is why we offer the Primus Expedition Service, applicable to any expedition stove (Ulti, OmniLite T1, OmniFuel and MultiFuel) sold from 2015 onwards. In the unlikely event the stove should fail due to defective materials or construction, we will help the original owner by sending spare parts, repair the stove or replace it – free of charge.

See www.primusequipment.com for a more extensive description and terms and conditions.



DESIGNED IN SWEDEN Step back in time to 1892, to a blacksmith workshop in the heart of Stockholm. Here, visionaries F. W. Lindqvist and J. V. Svenson invented the world's first soot-free kerosene stove. Being the first of its kind, they aptly named it Primus (meaning 'first').

The name became synonymous with reliable stoves, becoming the top choice for adventurers embarking on both initial ascents and demanding expeditions. From pioneering journeys to the South Pole with Roald Amundsen in 1911 to the iconic conquest of Mount Everest by Tenzing Norgay and Edmund Hillary in 1953, Primus stoves have etched their mark in history, fueling humanity's most extreme adventures, a legacy that lives on to this day!



OUR CHOICES

CORK Cork production is considered sustainable due to the fact that the cork tree is not cut down to obtain the material, only the bark is stripped – thus allowing the tree to continue to live and grow. Cork makes a great insulator as it offers a low level of thermal conductivity, while its resistance to moisture and liquid allow it to be used in a variety of environments.

BIO-BASED PLASTIC Materials such as starch, cellulose, wood, sugar and biomass are used as a substitute for fossil fuel to produce bioplastics. This makes the bioplastic production a more sustainable activity compared to conventional plastic production.

STAINLESS STEEL Stainless steel is an extremely durable material making it perfectly suited for outdoor pots, pans, bowls, plates, and glasses. The high resistance to rust together with its resistance to imparting flavors makes stainless steel products lifelong companions that are 100% recyclable.

ECO POLY-COTTON Leveraging upon the research and development completed by our friends at Fjällräven, we are excited to add their sustainable G-1000 ECO fabric into selected products. Built upon their classic G-1000 Original material, the G-1000 ECO is made from re-cycled polyester and organic cotton. G-1000 material is strong but light, ventilates but is resistant to water. By adding Greenland Wax, G-1000 becomes more water/drip resistant and is easy to clean.

FUEL EFFICIENCY Conventional camp stoves have an efficiency rate of 40% – more than half of the energy is wasted! In response, we designed the PrimeTech Stove System to achieve an efficiency rate close to 80 percent.

By combining three technologies: a built-in heat exchanger in the pot, an integrated windscreen that protects the flame, and a burner optimized for the PrimeTech Pot, we achieved nearly double the efficiency of a normal camp stove. Carry half fuel, produce half emissions.

CLIMATE NEUTRAL FUEL Primus gas has been CO2 neutral since 2015. Each year, we compensate for the carbon emissions from our gas and metal canisters by donating and supporting green initiative projects via First Climate. Since last year we are also offsetting the emissions from our Powerfuel, making all our fuel carbon offset.

For our emissions 2022 we have supported a project in Istanbul, Turkey developing and constructing facilities converting landfill gases from two landfills into electric energy. The project is Gold Standard certified (GS ID 707).

* STOVE GUIDE

CHOOSE STOVE BASED ON YOUR NEEDS Finding the right stove is much like cooking a meal. There are a few things to consider to succeed. Like how far you will travel and by what means, how many people you will cook for, and the weather conditions. We have listed the ultimate checklist to figure out which stove to choose.

WEATHER CONDITIONS Are you someone who ventures out in both summer and winter? Are your outings mostly on calm days, or do you need to be prepared for harsh winds and sub-zero temperatures? To ensure you're equipped for whatever conditions you encounter, we offer different kitchens tailored to these diverse needs, providing you with confidence and security in every situation.

WEIGHT TO CARRY Do you prefer to be as fast and free as the wind? Or at least feel like it. And only need to boil soups or make a quick cup of coffee? Then the obvious choice for you is a stove with minimum weight. But equally important is a clever design that is optimized for taking up minimal space. With hassle-free packing. Is this what you're looking and cooking for? Then our lightweight stoves got your back on the trails, and you won't even feel it.

COOKING AMBITIONS There's a difference between warming and cooking. Preparing a whole meal from scratch demands more tasks than putting something in the microwave. The same is true outdoors. So before you choose a stove it's important to set your ambition. Are there multiple cooking tasks to manage? What is the desired speed of preparation? What cookware and utensils are needed in the process?

NUMBER OF PEOPLE Are you bringing anyone along for your adventure? Maybe even a few? In that case, you should always bring an outdoor stove that allows you to feed all your hungry family members or friends at once. If you for example want to cook pasta for four people you need a stove that makes it possible both in terms of pot size and flexibility. Go big or go home. (If you want to keep everyone happy.)



EXPEDITION
LONG ADVENTURES
EXTREME WEATHERS
REMOTE LOCATIONS



COMPETITION
FAST ADVENTURES
LIGHTWEIGHT
COMPACT
FAST & EASY



EXPLORATION
TRAIL ADVENTURES
PACKABLE
VERSATILE
EASY TO USE



TOURING
FAMILY ADVENTURES
EASY SET UP
VERSATILE
ALL-IN-ONE SYSTEM



CAMPING
COOKING FOCUS
COOK FOR SEVERAL
KITCHEN-LIKE EXPERIENCE



NEWS 2025

PRIMUS DRINKWARE combines classic Swedish design with practical, high-quality features for every outdoor adventure. With heritage-inspired colors and top-tier functionality, Primus offers a dependable drinkware solution wherever your journey leads.

PRIMUS COOKING GEAR Primus cooking solutions go beyond just preparing meals outdoors—it's about making cooking effortless and enjoyable. The latest cookware and utensils make it easy to bring prepped ingredients, boil water over a fire or camp stove, and even scoop up the last bites from a meal bag.

STOVE UPDATES AND ADDITIONS We're always pushing to improve our equipment. Our product team is dedicated to innovation, constantly enhancing our stoves for even better performance. In 2025, the Micron Stove will be upgraded to be even lighter, while maintaining its compact design—making it the perfect choice for lightweight backpackers. Paired with the new 120g Trek Pot, it's an ideal companion for outdoor cooking.

Additionally, the Lite XL Stove System now offers new color options, providing backpackers and explorers with more choices to suit their style.

PRIMUS NEWS2025 DRINKWARE

CLASSIC LIGHT VACUUM BOTTLE 0.35 L

Art. no	Name
P743490	● Classic Light Vacuum Bottle 0.35L Black
P743500	○ Classic Light Vacuum Bottle 0.35L Stainless Steel
P743510	● Classic Light Vacuum Bottle 0.35L Summit Blue
P743520	● Classic Light Vacuum Bottle 0.35L Olive Drab Green
P743730	● Classic Light Vacuum Bottle 0.35L Pale Peach
P743740	● Classic Light Vacuum Bottle 0.35L Stone Gold

CLASSIC LIGHT VACUUM BOTTLE 0.5 L

Art. no	Name
P743530	● Classic Light Vacuum Bottle 0.5L Black
P743540	○ Classic Light Vacuum Bottle 0.5L Stainless Steel
P743550	● Classic Light Vacuum Bottle 0.5L Summit Blue
P743560	● Classic Light Vacuum Bottle 0.5L Olive Drab Green
P743750	● Classic Light Vacuum Bottle 0.5L Pale Peach
P743760	● Classic Light Vacuum Bottle 0.5L Stone Gold

CLASSIC LIGHT VACUUM BOTTLE 0.75 L

Art. no	Name
P743610	● Classic Light Vacuum Bottle 0.75L Black
P743620	○ Classic Light Vacuum Bottle 0.75L Stainless Steel
P743630	● Classic Light Vacuum Bottle 0.75L Summit Blue
P743600	● Classic Light Vacuum Bottle 0.75L Olive Drab Green
P743770	● Classic Light Vacuum Bottle 0.75L Pale Peach
P743780	● Classic Light Vacuum Bottle 0.75L Stone Gold

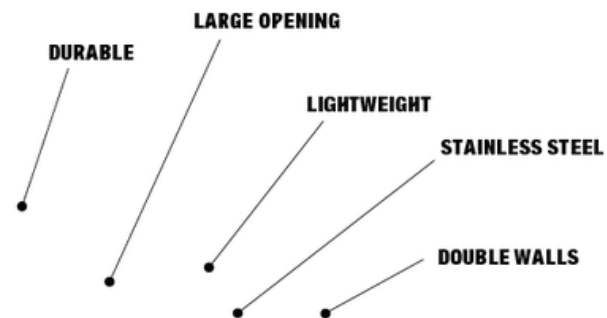

CLASSIC LIGHT VACUUM BOTTLE 1 L

Art. no	Name
P743490	● Classic Light Vacuum Bottle 1L Black
P743500	○ Classic Light Vacuum Bottle 1L Stainless Steel
P743510	● Classic Light Vacuum Bottle 1L Summit Blue
P743640	● Classic Light Vacuum Bottle 1L Olive Drab Green
P743790	● Classic Light Vacuum Bottle 1L Pale Peach
P743800	● Classic Light Vacuum Bottle 1L Stone Gold





PRIMUS NEWS2025 DRINKWARE

KLUNKEN VACUUM BOTTLE 0.5 L

Art. no	Name
P743840	 Klunken Vacuum Bottle 0.5L Pale Peach
P743850	 Klunken Vacuum Bottle 0.5L Stone Gold

KLUNKEN VACUUM BOTTLE 0.7 L

Art. no	Name
P743820	 Klunken Vacuum Bottle 0.7L Pale Peach
P743830	 Klunken Vacuum Bottle 0.7L Stone Gold

KOPPEN TREKKING MUG 0.3 L

Art. no	Name
P743650	 Koppen Trekking Mug 0.3L Stainless Steel

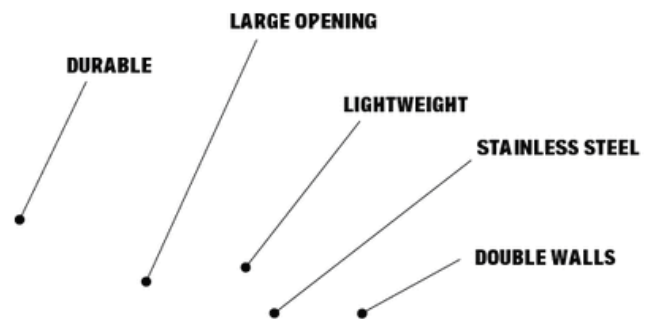

PRIMUS NEWS2025 COOKWARE

CAMPFIRE KETTLE

Art. no	Name
P743680	Campfire Kettle 0.9L Stainless Steel
P743810	Campfire Kettle 1.5L Stainless Steel

PREPPING BOWL WITH LID

Art. no	Name
P743660	Prepping Bowl with lid 0.6L Stainless Steel
P743670	Prepping Bowl with lid 1L Stainless Steel

LONG HANDLE SPOON ALU

Art. no	Name
P743480	Long Handle Spoon Alu

TWO SIZES
LEAK PROOF
STACKABLE
SALAD INSERT

ROBUST
LIGHTWEIGHT
STAINLESS STEEL
LARGE OPENING
COPPER PLATING



PRIMUS NEWS2025 MICRON III STOVE

MICRON III STOVE

Art. no	Name
P321493	Micron II Piezo
P321492	Micron II

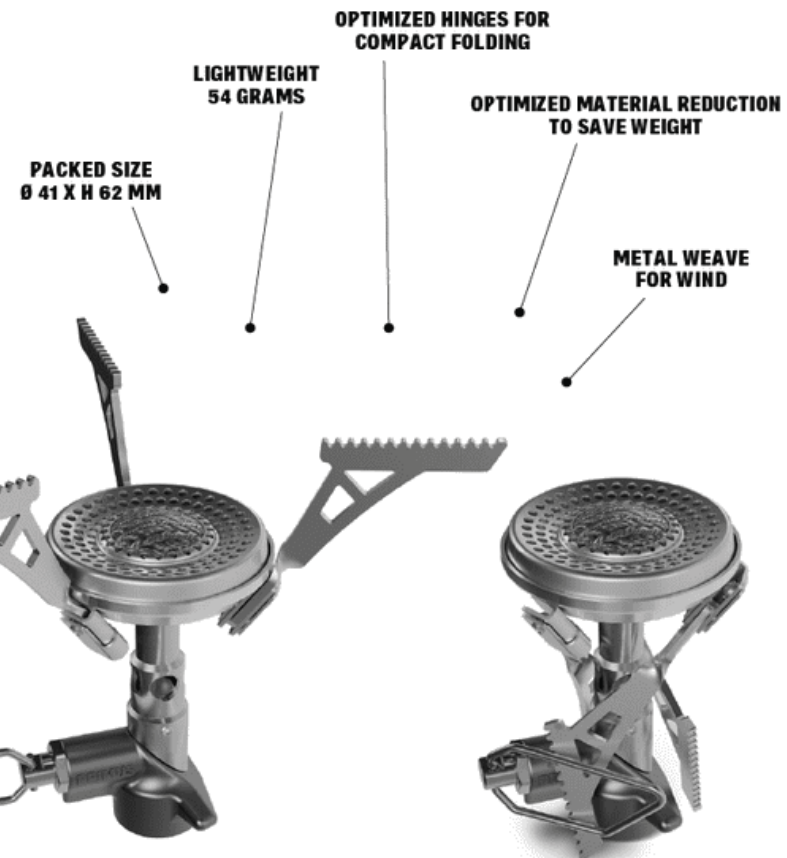

PRIMUS NEWS2025 STOVE SET VARIATIONS

LITE XL STOVE SYSTEM

Art. no	Name
P356041	● Primus Lite XL Stove System Blue
P356042	● Primus Lite XL Stove System Fern

PRIMETECH STOVE SYSTEM

Art. no	Name
P351038	● Primetech Stove Set 2x1.1.3L with pan
P351039	● Primetech Stove Set 1x1.1.3L with pan
P351040	● Primetech Stove Set 2x1.2.3L with pan
P351041	● Primetech Stove Set 1x1.2.3L with pan



NEW COLORS

2 X NEW VARIANTS



PRIMUS NEWS2025 SIP POWER FUEL

SIP POWER FUEL 1L

Art. no Name

P220995 ● Primus Lite XL Stove System



PRIMUS NEWS2025 TREK POT

TREK POT UL 0.8 L

Art. no Name

P745250 ● Trek Pot UL 0.8 L

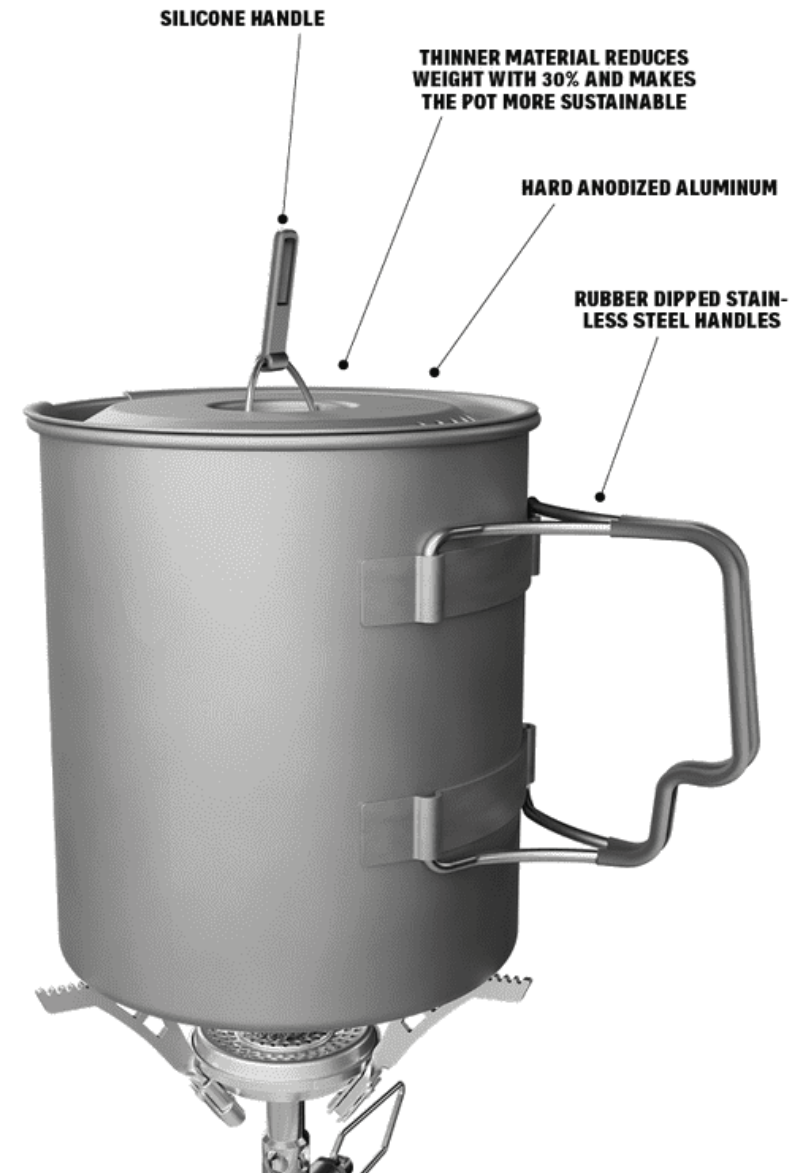
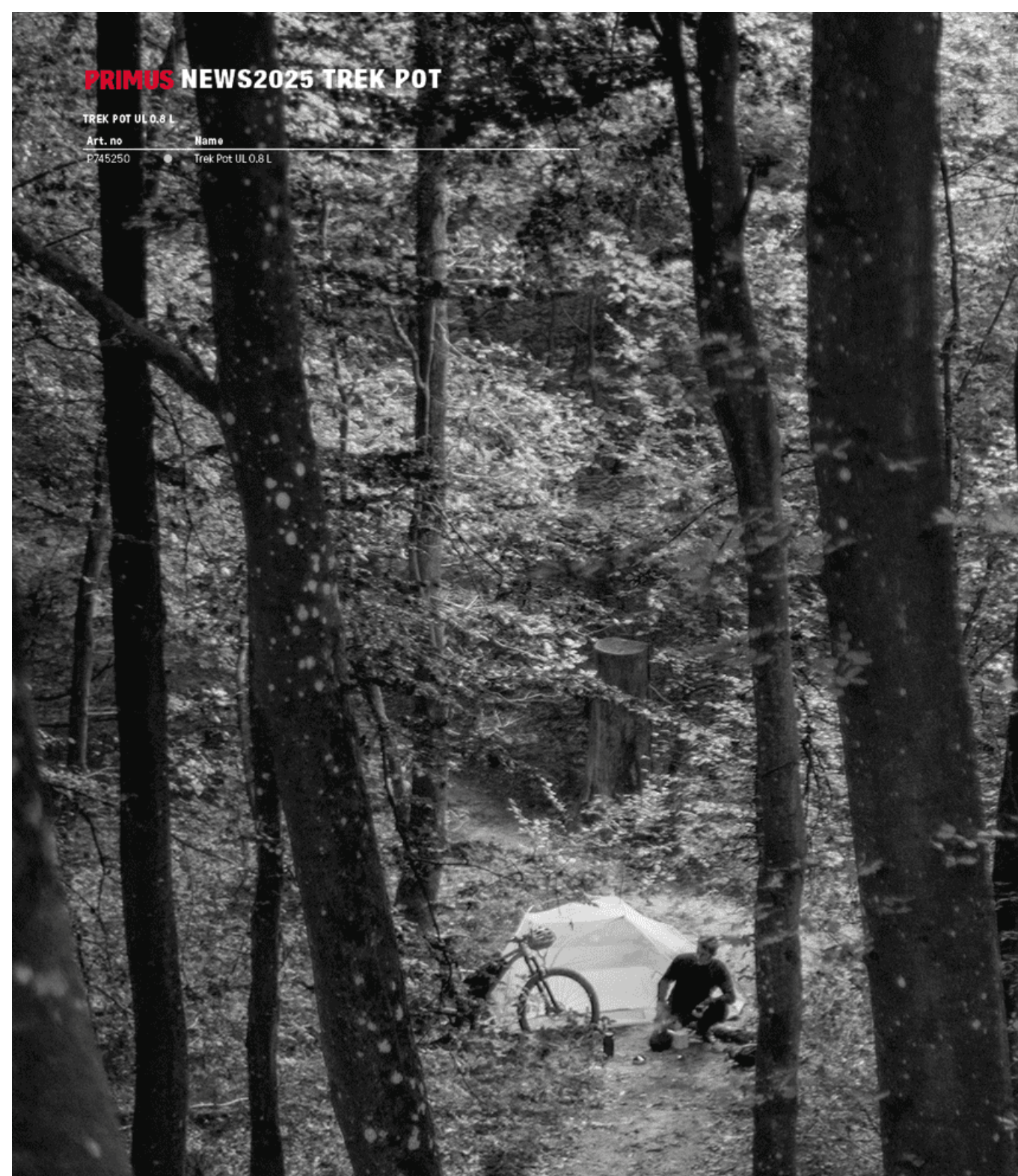



STOVES AND LANTERNS



MICRON III PIEZO

ART. NO. P321493



This lightweight and foldable sit-on-top stove is so compact that it can fit in almost any backpacking pack pocket.

- Aluminum valve provides an ultra-lightweight backpacking stove
- Pot supports fold down making for compact, pocket size stove
- Oversized and foldable control valve handle for ease of use
- Narrow high speed flame
- Remote, matchstick-style Piezo igniter included (Piezo version only)
- Comes with a nylon storage bag
- Invented in Sweden, made in Europe
- Gas NOT included

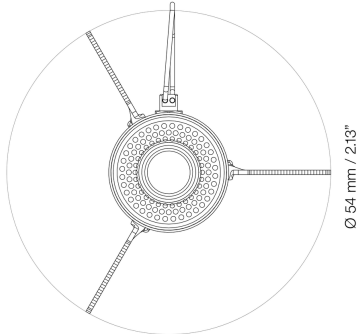
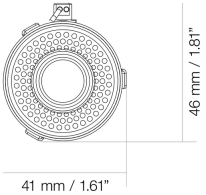
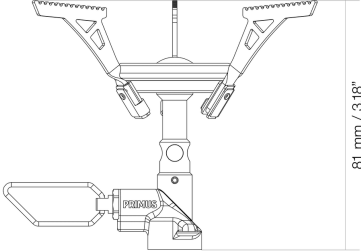
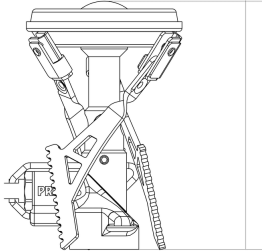

Accessories **Related products**



P731722
LiTech Trek
Kettle



P321492
Micron III

Weight	73 g
Power	2600 W
Boiling Time	- min with PrimeTech Pot 2:30 (0.5 liter) min with Regular Pot
Serving Group Size	1 - 2 People
Fuel Consumption	185 g/h

MICRON III

ART. NO. P321492



This lightweight and foldable sit-on-top stove is so compact that it can fit in almost any backpacking pack pocket.

- Aluminum valve provides an ultra-lightweight backpacking stove
- Pot supports fold down making for compact, pocket size stove
- Oversized and foldable control valve handle for ease of use
- Narrow high speed flame
- Remote, matchstick-style Piezo igniter included (Piezo version only)
- Comes with a nylon storage bag
- Invented in Sweden, made in Europe
- Gas NOT included

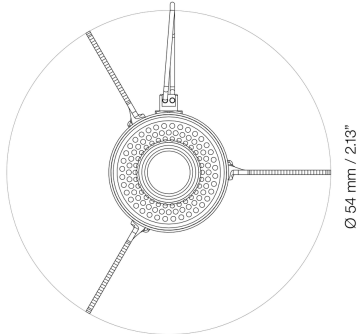
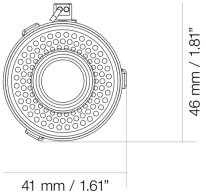
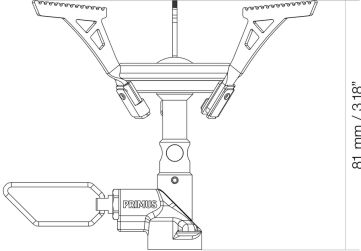
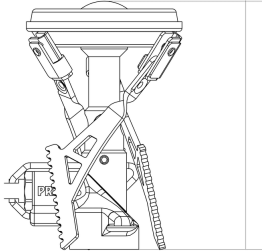

Accessories **Related products**



P731722
LiTech Trek
Kettle



P321493
Micron III
Piezo

Weight	58 g
Power	2600 W
Boiling Time	2:30 (0.5 liter) min with Regular Pot
Serving Group Size	1 - 2 People
Fuel Consumption	185 g/h

EXPRESS STOVE PIEZO

ART. NO. P321485



A unique combination of lightweight and durable with a foldable design easily packs up but is perfect for big pots when in use.

- Lightweight backpacking stove
- Pot supports fold together making for a compact, pocket size stove
- Control valve for precise flame control
- Narrow high speed flame for wind resistance
- Piezo ignition included, no lighter required
- Comes with a nylon storage bag
- Invented in Sweden, made in Estonia
- Gas NOT included

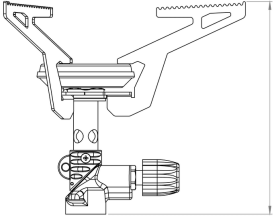
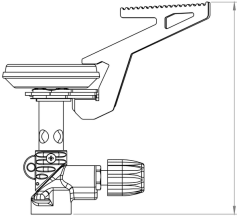

Accessories **Related products**



Weight	103 g
Power	2600 W
Boiling Time	2:30 min with PrimeTech Pot 3:30 min with Regular Pot
Serving Group Size	1 - 2 People
Fuel Consumption	185 g/h

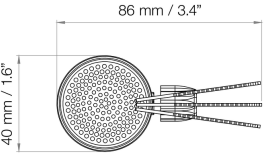
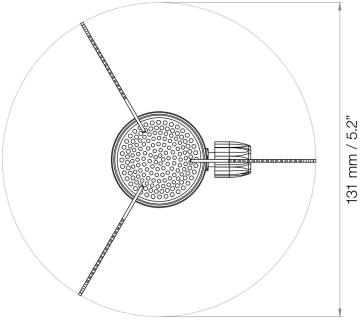

EXPRESS STOVE

ART. NO. P321484



A unique combination of lightweight and durability with foldable design easily packs up but is perfect for big pots when in use.

- Lightweight backpacking stove
- Pot supports fold together making for a compact, pocket size stove
- Control valve for precise flame control
- Narrow high speed flame for wind resistance
- Comes with a nylon storage bag
- Invented in Sweden, made in Estonia
- Gas NOT included

Accessories **Related products**

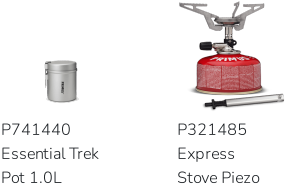

P741440
Essential Trek
Pot 1.0L

P321485
Express
Stove Piezo

Weight	88 g
Power	2600 W
Boiling Time	2:30 min with PrimeTech Pot 3:30 min with Regular Pot
Serving Group Size	1 - 2 People
Fuel Consumption	185 g/h

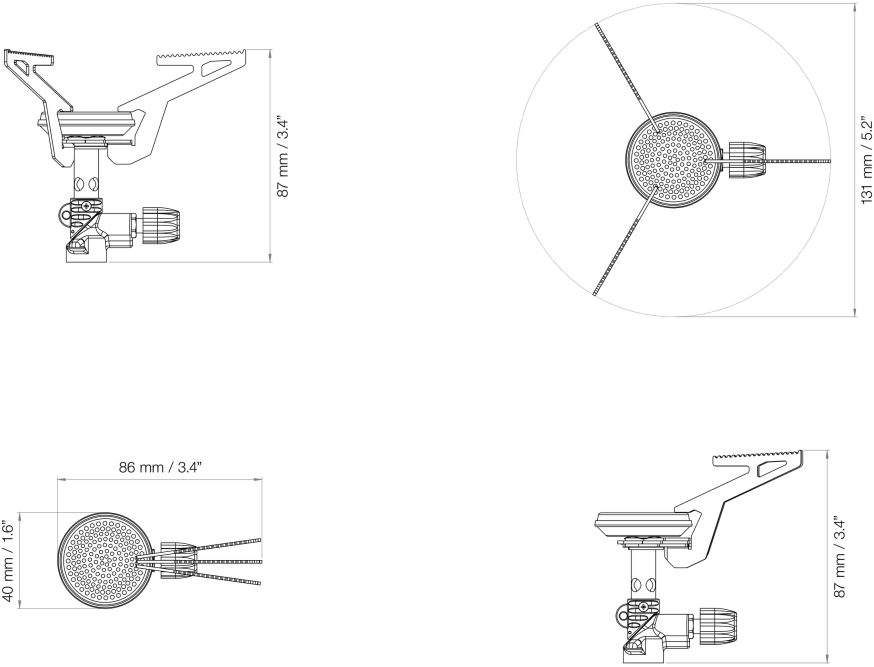

KUCHOMA STOVE US

ART. NO. P440081



BBQ with friends just about anywhere with this portable and functional gas-powered grill.

- Light, compact, and portable, this grill allows you to BBQ just about anywhere
- Designed to be carried, the wood-trimmed handle locks the stove closed while a spring-action locking mechanism keeps the regulator in place
- Horizontal burner tube distributes heat for even grilling
- Deep hood provides plenty of room for thick steaks while sealing in heat and flavor
- Piezo ignition, no lighter required
- Steel legs raise the grill and snap into place to give you more table space, and fold away for transport
- 1lb propane canister stand included (NorAm market)
- Regulated valve for precise flame and heat control and fuel efficient cooking
- Invented in Sweden, made in Europe. Gas NOT included

Accessories Related products



P741100
Bag for 4400

Weight	4600 g
Power	2500 W
Boiling Time	
Serving Group Size	1 - 10 People
Fuel Consumption	180 g/h

MIMER DUO STOVE

ART. NO. P224344



Robust, reliable, and always ready to use, this sit-on-top stove offers a wide flame great for larger pots.

- Robust and durable with no folding parts, this stove is incredibly easy to use and can be passed down for generations
- Wide flame excels at heating larger pots to cook for 1-3 people
- Static 4-point pot supports offer extra stability and wind resistance while comfortably holding a variety of pot sizes
- Available in Duo, fitting both threaded (Lindal) and non-threaded canister valves
- Gas NOT included



Accessories



P740310 LiTech Pot Set 1.3L
P737420 LiTech Frying Pan

Related products



P224394 Mimer Stove
P324612 Mimer Stove Kit II
P224383 Classic Trail Stove US

Weight	233 g
Power	2800 W
Boiling Time	2:30 min with PrimeTech Pot 3:40 min with Regular Pot
Serving Group Size	1 - 3 People
Fuel Consumption	200 g/h

MIMER STOVE

ART. NO. P224394

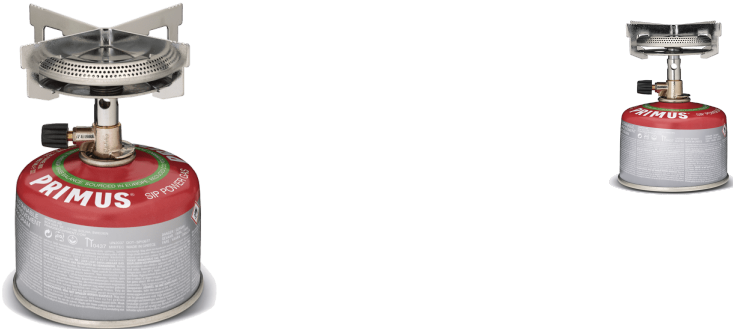

Robust, reliable, and always ready to use, this sit-on-top stove offers a wide flame great for larger pots.

- Robust and durable with no folding parts, this stove is incredibly easy to use and can be passed down for generations
- Wide flame excels at heating larger pots to cook for 1-3 people
- Static 4-point pot supports offer extra stability and wind resistance while comfortably holding a variety of pot sizes
- Available in Duo, fitting both threaded (Lindal) and non-threaded canister valves
- Gas NOT included

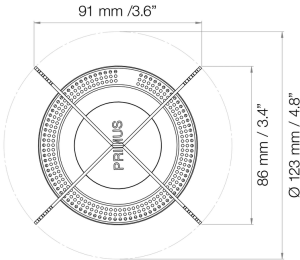
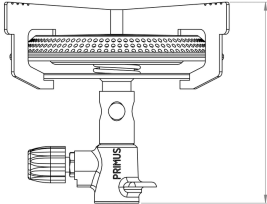

Accessories



P740310 LiTech Pot Set 1.3L
 P737420 LiTech Frying Pan

Related products



P224344 Mimer Duo Stove
 P324612 Mimer Stove Kit II
 P224383 Classic Trail Stove US

Weight	195 g
Power	2800 W
Boiling Time	3:30 min with Regular Pot
Serving Group Size	1 - 3 People
Fuel Consumption	200 g/h

ESSENTIAL TRAIL STOVE DUO

ART. NO. P351140

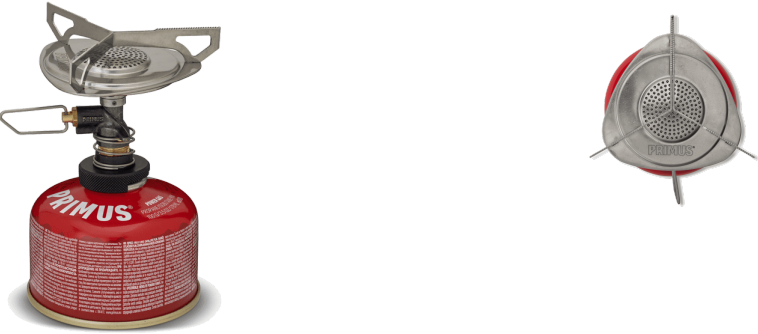

A trekking essential for novices and experienced outdoor cooks alike, the Essential Trail Stove offers precise flame control.

- Compact, lightweight, easy to use and always ready to cook
- Wind-blocking pot supports keep the flame strong and steady in windy conditions while comfortably holding a variety of pot sizes
- Laminar Flow Burner Technology, offers a lower center of gravity making the stove stable, lighter and more compact
- Control valve ensures precise flame control
- Available in Duo, fitting both threaded (Lindal) and non-threaded canister valves
- Invented in Sweden, made in Europe
- Gas NOT included

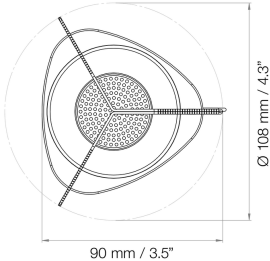
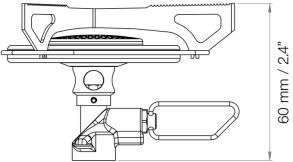

Accessories Related products

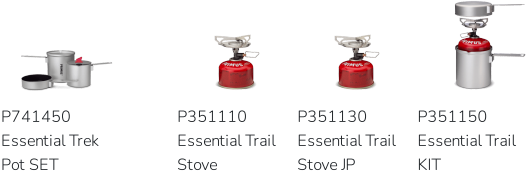

P741450 Essential Trek Pot SET P351110 Essential Trail Stove P351130 Essential Trail Stove JP P351150 Essential Trail KIT

Weight	159 g
Power	2500 W
Boiling Time	3:30 min with Regular Pot
Serving Group Size	1 - 2 People
Fuel Consumption	180 g/h

ESSENTIAL TRAIL STOVE

ART. NO. P351110



A trekking essential for novices and experienced outdoor cooks alike, the Essential Trail Stove offers precise flame control.

- Compact, lightweight, easy to use and always ready to cook
- Wind-blocking pot supports keep the flame strong and steady in windy conditions while comfortably holding a variety of pot sizes
- Laminar Flow Burner Technology, offers a lower center of gravity making the stove stable, lighter and more compact
- Control valve ensures precise flame control
- Available in Duo, fitting both threaded (Lindal) and non-threaded canister valves
- Invented in Sweden, made in Europe
- Gas NOT included

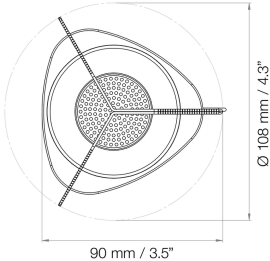
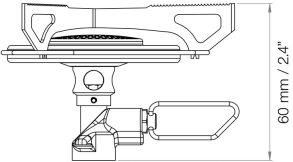

Accessories



P741450 Essential Trek Pot SET
P741420 Trek Pot SET

Related products

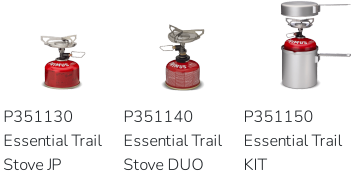

P351130 Essential Trail Stove JP
P351140 Essential Trail Stove DUO
P351150 Essential Trail KIT

Weight	112 g
Power	2500 W
Boiling Time	3:30 min with Regular Pot
Serving Group Size	1 - 2 People
Fuel Consumption	180 g/h

FRIGG W.PIEZO

ART. NO. P208971



Large and robust single burner stove attaches directly to Primus refillable propane canister.

- Wide flame excels at heating larger pots to cook for larger groups
- Robust, reliable and easy-to-use, this stove will hold up to many years of use
- Static 4-point pot supports offer extra stability and wind resistance
- Drainage holes protect the flame in case of a boil over
- Piezo ignition, no lighter required Carry handle for easy transport
- Connects to a refillable propane cylinder with M14x1.5 connections
- Gas NOT included

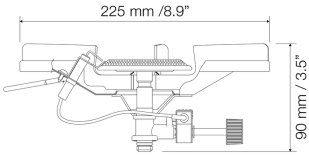

Accessories



P738005 CampFire Pot S.S. 5L
 P738000 CampFire Frying Pan S.S. 25cm

Weight	726 g
Power	2200 W
Boiling Time	6:00 min with Regular Pot
Serving Group Size	1 - 6 People
Fuel Consumption	155 g/h

PRIMETECH STOVE SET II 2X2.3L W. PAN

ART. NO. P351042



All-in-one cooking kit made to feed the family and friends on outdoor adventures.

- Fuel-efficient, all-in-one stove system with integrated Laminar Flow Burner Technology, and windscreen
- Remote-canister stove offers max stability due to lower center of gravity
- Fine control valve for precise flame and heat control and regulated valve
- Two lightweight hard-anodized aluminum pots -one with integrated heat exchanger and ceramic, non-stick coating - nest into each other for easy packing
- Frying pan/pot lid with non-stick ceramic-coating works as a skillet or keeps heat in while boiling water
- Remote, independent t-grip Piezo igniter included, no lighter required
- Removable Crimp Pot Gripper handles hot pots and pans with ease
- Regulated valve for precise flame and heat control and fuel efficient cooking
- Invented in Sweden, made in Europe
- Gas NOT included

Weight	
Power	
Boiling Time	
Serving Group Size	
Fuel Consumption	

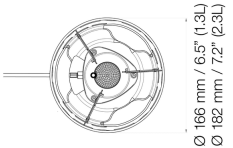
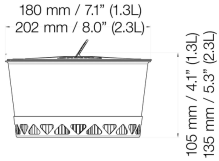
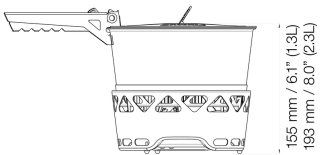

PRIMETECH STOVE SET II 2X1.3L W. PAN

ART. NO. P351043



All-in-one cooking kit made to feed the family and friends on outdoor adventures.

- Fuel-efficient, all-in-one stove system with integrated Laminar Flow Burner Technology, and windscreen
- Remote-canister stove offers max stability due to lower center of gravity
- Fine control valve for precise flame and heat control and regulated valve
- One lightweight hard-anodized aluminum pot with integrated heat exchanger and ceramic, non-stick coating
- Frying pan/pot lid with non-stick ceramic-coating works as a skillet or keeps heat in while boiling water
- Remote, independent t-grip Piezo igniter included, no lighter required
- Removable Crimp Pot Gripper handles hot pots and pans with ease
- Regulated valve for precise flame and heat control and fuel efficient cooking
- Invented in Sweden, made in Europe
- Gas NOT included

Weight	
Power	
Boiling Time	
Serving Group Size	
Fuel Consumption	

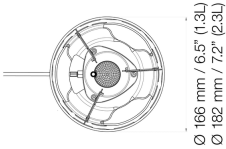
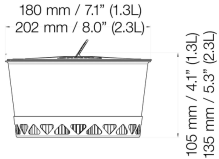
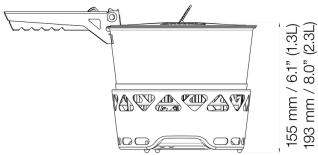

PRIMETECH STOVE SET II 2.3L

ART. NO. P351044



Easily feed the backcountry group gourmet meals with this fuel-efficient stove system that brings along everything the chef needs to cook in one package.

- Fuel-efficient, all-in-one stove system with integrated Laminar Flow Burner Technology, and windscreen
- Remote-canister stove offers max stability due to lower center of gravity
- Regulated valve for precise flame and heat control and fuel efficient cooking
- Two lightweight hard-anodized aluminum pots -one with with integrated heat exchanger and ceramic, non-stick coating - nest into each other for easy packing
- Transparent lid with integrated colander and heat resistant silicone handle
- Remote, independent t-grip Piezo igniter included, no lighter required
- Removable Crimp Pot Gripper handles hot pots and pans with ease
- Regulated valve for precise flame and heat control and fuel efficient cooking
- Invented in Sweden, made in Europe
- Gas NOT included

Weight	
Power	
Boiling Time	
Serving Group Size	
Fuel Consumption	

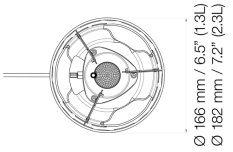
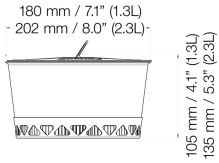
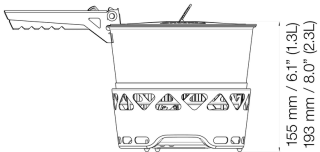

PRIMETECH STOVE SET II 1.3L

ART. NO. P351045



Easily feed the backcountry group gourmet meals with this fuel-efficient stove system that brings along everything the chef needs to cook in one package.

- Fuel-efficient, all-in-one stove system with integrated Laminar Flow Burner Technology, and windscreen
- Remote-canister stove offers max stability due to lower center of gravity
- Regulated valve for precise flame and heat control and fuel efficient cooking
- Two lightweight hard-anodized aluminum pots -one with with integrated heat exchanger and ceramic, non-stick coating - nest into each other for easy packing
- Transparent lid with integrated colander and heat resistant silicone handle
- Remote, independent t-grip Piezo igniter included, no lighter required
- Removable Crimp Pot Gripper handles hot pots and pans with ease
- Regulated valve for precise flame and heat control and fuel efficient cooking
- Invented in Sweden, made in Europe
- Gas NOT included

Weight	
Power	
Boiling Time	
Serving Group Size	
Fuel Consumption	

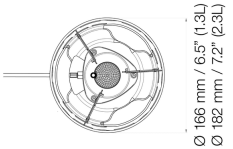
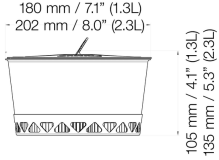
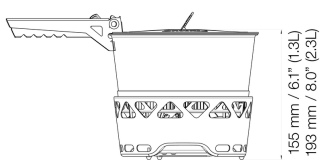

PRIMETECH STOVE SET II 1X2.3L W. PAN

ART. NO. P351046



All-in-one cooking kit made to feed the family and friends on outdoor adventures.

- Fuel-efficient, all-in-one stove system with integrated Laminar Flow Burner Technology, and windscreen
- Remote-canister stove offers max stability due to lower center of gravity
- Fine control valve for precise flame and heat control and regulated valve
- One lightweight hard-anodized aluminum pot with integrated heat exchanger and ceramic, non-stick coating
- Frying pan/pot lid with non-stick ceramic-coating works as a skillet or keeps heat in while boiling water
- Remote, independent t-grip Piezo igniter included, no lighter required
- Removable Crimp Pot Gripper handles hot pots and pans with ease
- Regulated valve for precise flame and heat control and fuel efficient cooking
- Invented in Sweden, made in Europe
- Gas NOT included

Weight	
Power	
Boiling Time	
Serving Group Size	
Fuel Consumption	

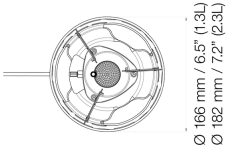
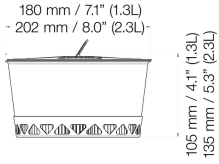
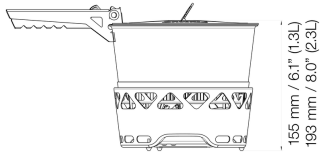

PRIMETECH STOVE SET II 1X1.3L W. PAN

ART. NO. P351047



All-in-one cooking kit made to feed the family and friends on outdoor adventures.

- Fuel-efficient, all-in-one stove system with integrated Laminar Flow Burner Technology, and windscreen
- Remote-canister stove offers max stability due to lower center of gravity
- Fine control valve for precise flame and heat control and regulated valve
- One lightweight hard-anodized aluminum pot with integrated heat exchanger and ceramic, non-stick coating
- Frying pan/pot lid with non-stick ceramic-coating works as a skillet or keeps heat in while boiling water
- Remote, independent t-grip Piezo igniter included, no lighter required
- Removable Crimp Pot Gripper handles hot pots and pans with ease
- Regulated valve for precise flame and heat control and fuel efficient cooking
- Invented in Sweden, made in Europe
- Gas NOT included

Weight	
Power	
Boiling Time	
Serving Group Size	
Fuel Consumption	

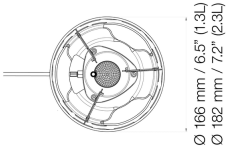
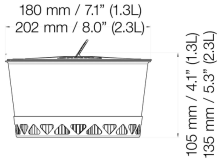
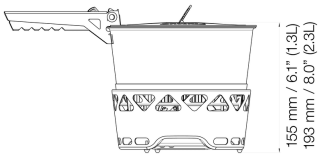

ESSENTIAL STOVE SET 2.3L

ART. NO. P351031



All-in-one cooking kit made to feed the family and friends on outdoor adventures.

- Fuel-efficient, all-in-one stove system with integrated Laminar Flow Burner Technology, and windscreen
- Remote-canister stove offer max stability due to lower center of gravity
- Fine control valve for precise flame and heat control
- Two lightweight anodized aluminum pots, nest into each other for easy packing
- Frying pan/pot lid with non-stick ceramic-coating works as a skillet or keeps heat in while boiling water
- Removable Pot Gripper handles hot pots and pans with ease
- Comes with a storage bag and a foldable heat reflector
- Invented in Sweden, made in Europe
- Gas NOT included

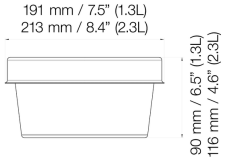

Accessories Related products



P738007
CampFire
Prep Set



P351030
Essential
Stove Set
1.3L

Weight	1002 g
Power	2000 W
Boiling Time	4:30 min with Regular Pot
Serving Group Size	2 - 5 People
Fuel Consumption	116 g/h

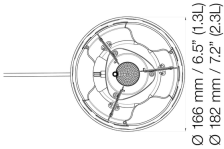

ESSENTIAL STOVE SET 1.3L

ART. NO. P351030



All-in-one cooking kit made to feed the family and friends on outdoor adventures.

- Fuel-efficient, all-in-one stove system with integrated Laminar Flow Burner Technology, and windscreen
- Remote-canister stove offer max stability due to lower center of gravity
- Fine control valve for precise flame and heat control
- Two lightweight anodized aluminum pots, nest into each other for easy packing
- Frying pan/pot lid with non-stick ceramic-coating works as a skillet or keeps heat in while boiling water
- Removable Pot Gripper handles hot pots and pans with ease
- Comes with a storage bag and a foldable heat reflector
- Invented in Sweden, made in Europe
- Gas NOT included

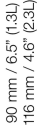
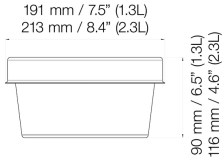
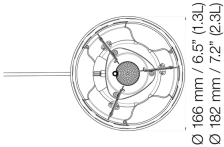

Accessories Related products



P738007
CampFire
Prep Set



P351031
Essential
Stove Set
2.3L

Weight	822 g
Power	2000 W
Boiling Time	4:30 min with Regular Pot
Serving Group Size	1 - 3 People
Fuel Consumption	116 g/h



MIMER STOVE KIT II

ART. NO. P324612

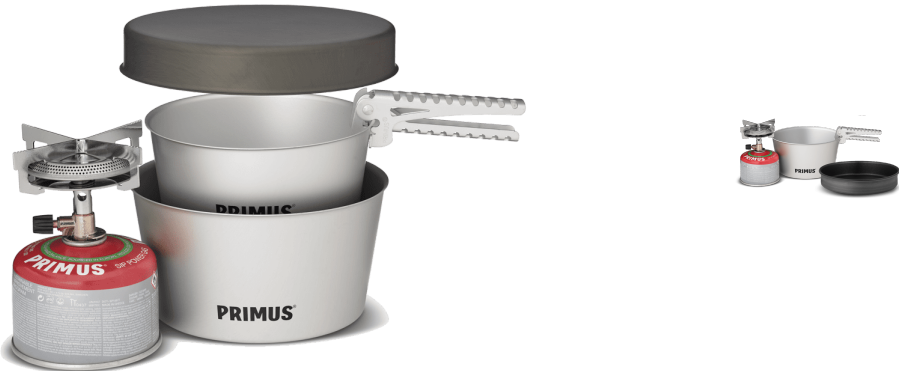

This classic camp kitchen with a robust, reliable stove, pots and frying pan will be your trekking cooking partner for generations.

- Robust and durable with no folding parts, this stove is incredibly easy to use and can be passed down for generations
- Wide flame excels at heating larger pots to cook for 1-3 people
- Static 4-point pot supports offer extra stability and wind resistance while comfortably holding a variety of pot sizes
- Two lightweight anodized aluminum pots (2.3 L & 1.3L) nest together for easy packing while frying pan/pot lid with ceramic, non-stick coating works as a skillet or pot lid
- Pot gripper handles hot pots and pans with ease
- Comes with a nylon storage bag
- Gas NOT included

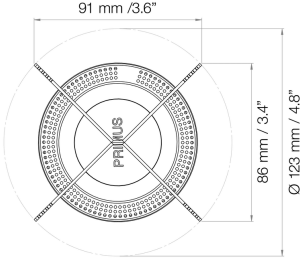
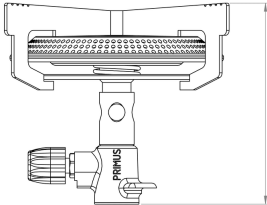

Accessories



P738007
CampFire
Prep Set

Weight	761 g
Power	2800 W
Boiling Time	2:30 min with PrimeTech Pot 3:40 min with Regular Pot
Serving Group Size	1 - 3 People
Fuel Consumption	200 g/h

ESSENTIAL TRAIL KIT

ART. NO. P351150

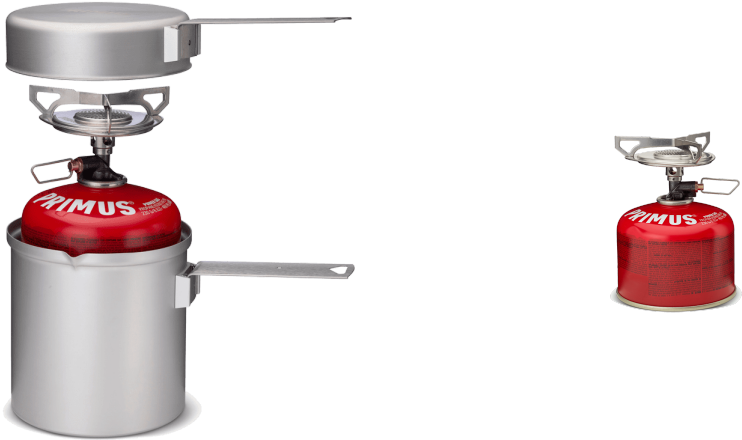

Compact all-in-one cooking kit for 1-2 people and everyday backpacking adventures.

- Compact, lightweight, easy to use and always ready to cook
- Wind-blocking pot supports keep the flame strong and steady in windy conditions while comfortably holding a variety of pot sizes
- Laminar Flow Burner Technology offers a lower center of gravity making the stove stable, lighter and more compact
- Our newest control valve allows for precise flame control
- Lightweight anodized aluminum pot (1 L) fits stove attached to the 230g canister for easy packing
- Frying pan/pot lid works as a skillet or keeps heat in while boiling water
- Two removable handles allow you to cook or transport this kit with ease
- Comes with a mesh storage bag
- Invented in Sweden, made in Europe
- Gas NOT included

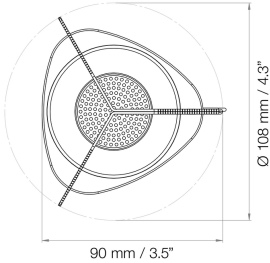
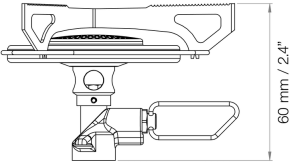

Related products

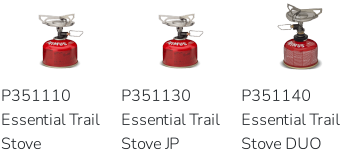

P351110 Essential Trail Stove
 P351130 Essential Trail Stove JP
 P351140 Essential Trail Stove DUO

Weight	350 g
Power	2500 W
Boiling Time	3:30 min with Regular Pot
Serving Group Size	1 - 2 People
Fuel Consumption	180 g/h

EASYFUEL DUO PIEZO

ART. NO. P327743



With a built-in, push-button igniter, this remote-canister gas stove with Duo-valve is ideal for camp cook beginners as well as more experienced backpackers.

- Robust, reliable and easy-to-use, this stove will hold up to years of use
- Compact and light to fit into any backpack
- Remote-canister stove, has max stability due to lower center of gravity
- Piezo ignition, no lighter required
- Available in Duo, fitting both threaded (Lindal) and non-threaded canister valves
- Comes with a nylon storage bag
- Invented in Sweden, made in Europe
- Gas NOT included

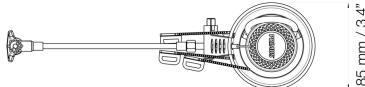
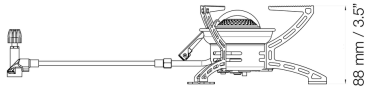

Accessories **Related products**



P740290
Essential Pot
Set 1.3L



P327793
EasyFuel II
Piezo

Weight	385 g
Power	3000 W
Boiling Time	2:50 min with PrimeTech Pot 3:50 min with Regular Pot
Serving Group Size	1 - 4 People
Fuel Consumption	215 g/h

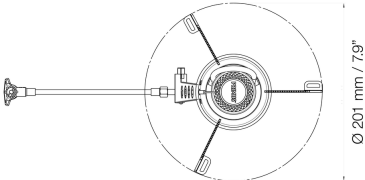

EASYFUEL II PIEZO

ART. NO. P327793



With a built-in, push-button igniter, this remote-canister gas stove with Duo-valve is ideal for camp cook beginners as well as more experienced backpackers.

- Robust, reliable and easy-to-use, this stove will hold up to years of use
- Compact and light to fit into any backpack
- Remote-canister stove, has max stability due to lower center of gravity
- Piezo ignition, no lighter required
- Available in Duo, fitting both threaded (Lindal) and non-threaded canister valves
- Comes with a nylon storage bag
- Invented in Sweden, made in Europe
- Gas NOT included

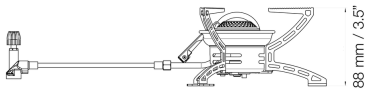
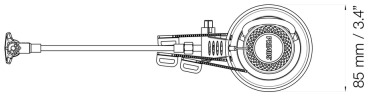

Accessories **Related products**



P740290
Essential Pot
Set 1.3L



P327743
EasyFuel Duo
Piezo

Weight	346 g
Power	3000 W
Boiling Time	2:50 min with PrimeTech Pot 3:50 min with Regular Pot
Serving Group Size	1 - 4 People
Fuel Consumption	215 g/h

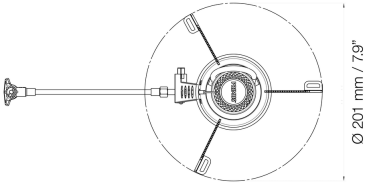

GRAVITY IV

ART. NO. P328992



Big enough to feed a crowd, but light enough to bring on demanding hikes and expeditions.

- Wide flame excels at heating larger pots to cook for 1-4 people
- Compact and light to fit into any backpack
- Remote-canister stove, has max stability due to lower center of gravity and 4-leg design
- Preheating coil excels at cooking in colder temperature
- Can be upgraded with Gravity MultiFuel Kit (not included) for use of liquid fuel
- Comes with a heat reflector and a nylon storage bag
- Invented in Sweden, made in Europe
- Gas NOT included

Weight	
Power	
Boiling Time	
Serving Group Size	
Fuel Consumption	

EXPRESS SPIDER II

ART. NO. P328485

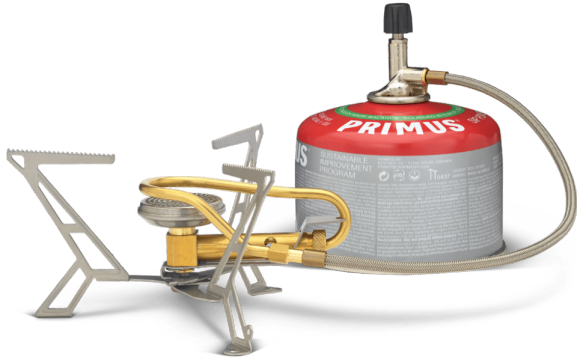

This lightweight alternative to sit-on-top stoves performs at low temperatures and can be converted to a multi fuel stove.

- Lightweight, compact and fits into the top pocket of any backpack
- Remote-canister stove construction, with a lower center of gravity for additional stability
- Narrow flame is fuel-efficient and compatible with Primus PrimeTech Pots with integrated heat exchanger
- Preheating coil excels at cooking in colder temperature
- Can be upgraded with Express Spider MultiFuel Kit (not included) for use of liquid fuel
- Comes with a heat reflector and a nylon storage bag
- Invented in Sweden, made in Europe
- Gas NOT included

Accessories



P741410
Trek Pot 1.0L

Weight	200 g
Power	2000 W
Boiling Time	3:35 min with PrimeTech Pot 5:00 min with Regular Pot
Serving Group Size	1 - 4 People
Fuel Consumption	145 g/h

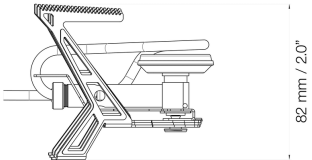
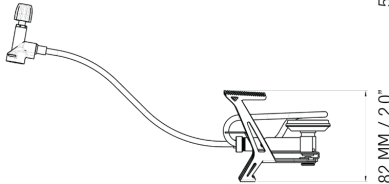
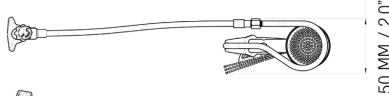
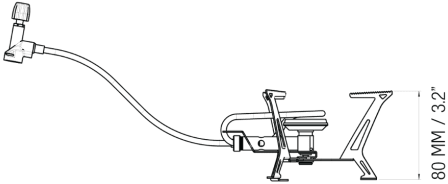
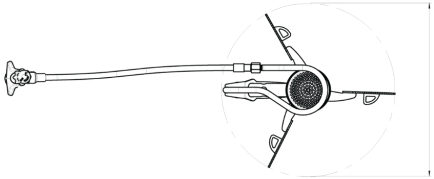

ULTI STOVE SYSTEM 1.7

ART. NO. P380010



The ultimate cooking solution no matter the weather, altitude, or landscape.

- Catalytic combustion and infrared radiation burner has no blue flame to be extinguished
- Pressure regulator enhances efficiency and ensures consistent heat output
- Remote canister hose system allows the fuel canister to be flipped upside down for use in colder weather
- Disk burner with low center of gravity and sturdy legs can be used on a variety of ground cover and provides a stable cooking base
- Legs fold under and into the burner base to lock in hose and valve into a compact unit
- Fuel-efficient pot system securely sits on burner when in use and holds/protects a 100g (1.0L) or a 230g (1.7L) fuel canister and burner for easy packing
- Hard-anodized aluminum pot and lid with pour spout has integrated heat exchanger.
- Sturdy handle allows you to easily hold the pot and folds over the lid to lock the stove system together in an impact protected package
- Comes with a mesh storage bag for the burner
- Invented in Sweden and Primus Expedition Service certified

Accessories Related products



P743050
Ulti Pot 1.0



P380000
Ulti Stove
System 1.0

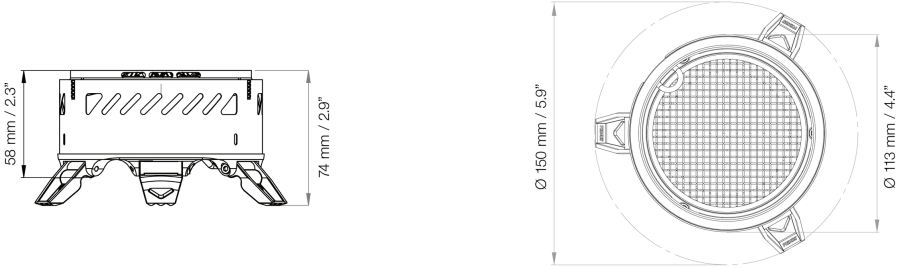

Weight	690 g
Power	3000 W
Boiling Time	3:30 min with PrimeTech Pot
Serving Group Size	1 - 4 People
Fuel Consumption	200 g/h

ULTI STOVE SYSTEM 1.0

ART. NO. P380000



The ultimate cooking solution no matter the weather, altitude, or landscape.

- Catalytic combustion and infrared radiation burner has no blue flame to be extinguished
- Pressure regulator enhances efficiency and ensures consistent heat output
- Remote canister hose system allows the fuel canister to be flipped upside down for use in colder weather
- Disk burner with low center of gravity and sturdy legs can be used on a variety of ground cover and provides a stable cooking base
- Legs fold under and into the burner base to lock in hose and valve into a compact unit
- Fuel-efficient pot system securely sits on burner when in use and holds/protects a 100g (1.0L) or a 230g (1.7L) fuel canister and burner for easy packing
- Hard-anodized aluminum pot and lid with pour spout has integrated heat exchanger.
- Sturdy handle allows you to easily hold the pot and folds over the lid to lock the stove system together in an impact protected package
- Comes with a mesh storage bag for the burner
- Invented in Sweden and Primus Expedition Service certified

Accessories



P743060 Ulti Pot 1.7
P743070 Ulti Pot 2.5

Related products



P380010 Ulti Stove System 1.7

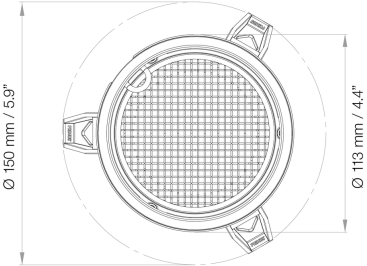
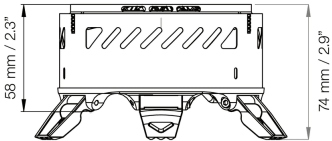

Weight	600 g
Power	3000 W
Boiling Time	3:30 min with PrimeTech Pot
Serving Group Size	1 - 2 People
Fuel Consumption	200 g/h

LITE XL STOVE SYSTEM

ART. NO. P356040



A larger version of the Lite Plus, this compact, lightweight and fuel-efficient top-mounted kitchen solution easily makes enough for 2 people in the backcountry or on the big wall.

- Burner locks securely to the pot when in use and packs together with a 230g gas canister inside pot for ultimate travel experience
- Oversized and foldable control valve for precise flame control
- Laminar Flow Burner Technology™ offers a lower center of gravity making the stove stable, lighter and more compact
- Piezo ignition, no lighter required
- Includes pot support pegs to use with any non-system pot or pan
- 1.0L hard-anodized aluminum pot with pour spout has integrated heat exchanger
- Adjustable and removable handle allows you to cook or transport pots with ease
- Cork-lined insulated pot sleeve made from G-1000 ECO Lite fabric with a sleeve pocket that holds accessories
- Bio-based plastic pot lid doubles as a cup
- Comes with a bio-based Canister Stand to attach on the gas canister for extra stability and a Hanging System when you can't find a flat space to cook

Accessories **Related products**



P734520
Coffee-Tea
Press for
731722,
356011



P356041
Lite XL Stove
System Blue



P356042
Lite XL Stove
System Fern

Weight	460 g
Power	1700 W
Boiling Time	2:30 (0,5 l) min with PrimeTech Pot
Serving Group Size	1 - 3 People
Fuel Consumption	120 g/h

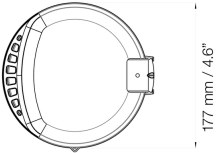
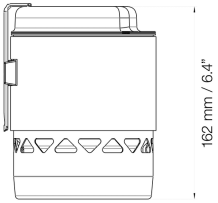
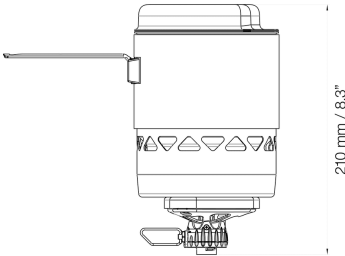

LITE XL STOVE SYSTEM FERN

ART. NO. P356042

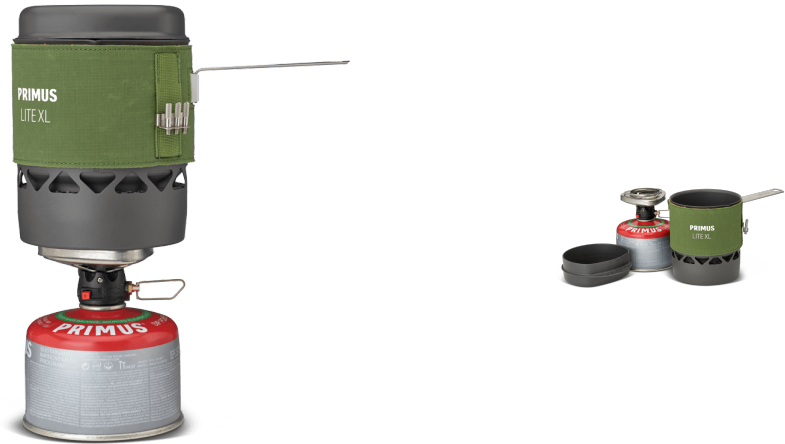

A larger version of the Lite Plus, this compact, lightweight and fuel-efficient top-mounted kitchen solution easily makes enough for 2 people in the backcountry or on the big wall.

- Burner locks securely to the pot when in use and packs together with a 230g gas canister inside pot for ultimate travel experience
- Oversized and foldable control valve for precise flame control
- Laminar Flow Burner Technology™ offers a lower center of gravity making the stove stable, lighter and more compact
- Piezo ignition, no lighter required
- Includes pot support pegs to use with any non-system pot or pan
- 1.0L hard-anodized aluminum pot with pour spout has integrated heat exchanger
- Adjustable and removable handle allows you to cook or transport pots with ease
- Cork-lined insulated pot sleeve made from G-1000 ECO Lite fabric with a sleeve pocket that holds accessories
- Bio-based plastic pot lid doubles as a cup
- Comes with a bio-based Canister Stand to attach on the gas canister for extra stability and a Hanging System when you can't find a flat space to cook

Accessories Related products



P734520
Coffee-Tea
Press for
731722,
356011

P356040
Lite XL Stove
System

P356041
Lite XL Stove
System Blue

Weight	460 g
Power	1700 W
Boiling Time	2:30 (0,5 l) min with PrimeTech Pot
Serving Group Size	1 - 3 People
Fuel Consumption	120 g/h

LITE XL STOVE SYSTEM BLUE

ART. NO. P356041



A larger version of the Lite Plus, this compact, lightweight and fuel-efficient top-mounted kitchen solution easily makes enough for 2 people in the backcountry or on the big wall.

- Burner locks securely to the pot when in use and packs together with a 230g gas canister inside pot for ultimate travel experience
- Oversized and foldable control valve for precise flame control
- Laminar Flow Burner Technology™ offers a lower center of gravity making the stove stable, lighter and more compact
- Piezo ignition, no lighter required
- Includes pot support pegs to use with any non-system pot or pan
- 1.0L hard-anodized aluminum pot with pour spout has integrated heat exchanger
- Adjustable and removable handle allows you to cook or transport pots with ease
- Cork-lined insulated pot sleeve made from G-1000 ECO Lite fabric with a sleeve pocket that holds accessories
- Bio-based plastic pot lid doubles as a cup
- Comes with a bio-based Canister Stand to attach on the gas canister for extra stability and a Hanging System when you can't find a flat space to cook

Accessories **Related products**



P734520
Coffee-Tea
Press for
731722,
356011

P356040
Lite XL Stove
System

P356042
Lite XL Stove
System Fern

Weight	460 g
Power	1700 W
Boiling Time	2:30 (0,5 l) min with PrimeTech Pot
Serving Group Size	1 - 3 People
Fuel Consumption	120 g/h

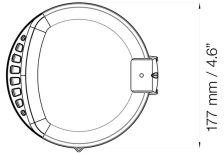
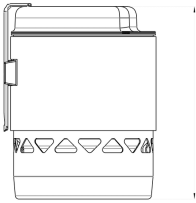
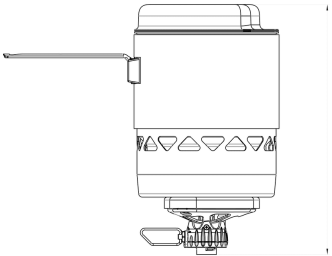

LITE PLUS STOVE SYSTEM FERN

ART. NO. P356031



Compact, lightweight and fuel efficient top-mounted kitchen solution for 1-2 people, for all of your backpacking needs.

- Lightweight system stove burner locks securely to the pot when in use and packs conveniently inside with a 100g gas canister for ultimate travel experience
- Oversized and foldable control valve for precise flame control
- Laminar Flow Burner Technology™ offers a lower center of gravity making the stove stable, lighter and more compact
- Piezo ignition, no lighter required
- Includes pot support pegs to use with any non-system pot or pan
- 0.5L hard-anodized aluminum pot with pour spout has integrated heat exchanger
- Cork-lined insulated pot sleeve made from G-1000 ECO Lite fabric with a sleeve pocket that holds accessories
- Bio-based plastic pot lid doubles as a cup
- Comes with a bio-based Canister Stand to attach on the gas canister for extra stability and a Hanging System when you can't find a flat space to cook
- Invented in Sweden, made in Europe. Gas NOT included

Accessories



P737570 Coffee-Tea Press for Lite+
 P741610 Longspoon Black

Related products



P356030 Lite Plus Stove System Black
 P356032 Lite Plus Stove System Blue
 P356033 Lite Plus Stove System Green
 P356034 Lite Plus Stove System Pink
 P356035 Lite Plus Stove System Orange

Weight	402 g
Power	1500 W
Boiling Time	2:45 (0.5 l) min with PrimeTech Pot
Serving Group Size	1 - 2 People
Fuel Consumption	100 g/h

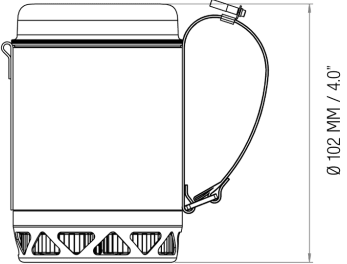

Ø 102 MM / 4.0"

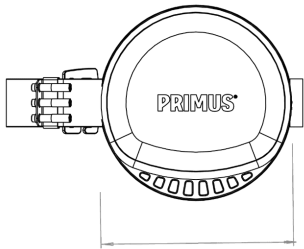

Ø 151 MM / 5.9"

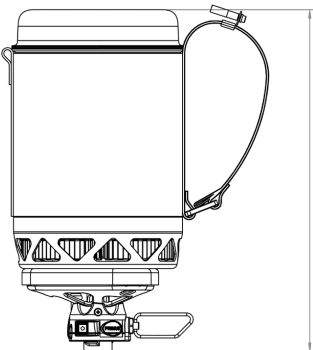

Ø 199 MM / 7.8"

LITE STOVE SYSTEM

ART. NO. P356020



Top-mounted and extremely fuel-efficient backpacking stove system for easy packing and efficient cooking.

- Lightweight system stove burner locks securely to the pot when in use and packs conveniently inside with a 100g gas canister for ultimate travel experience
- Large control valve for precise flame and heat control
- Laminar Flow Burner Technology™ offers a lower center of gravity making the stove stable, lighter and more compact
- Piezo ignition, no lighter required
- 0.5L hard-anodized aluminum pot with pour spout has integrated heat exchanger and felt sleeve
- Invented in Sweden, made in Europe
- Gas NOT included

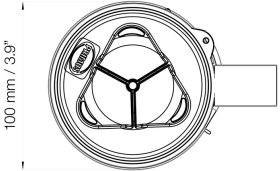
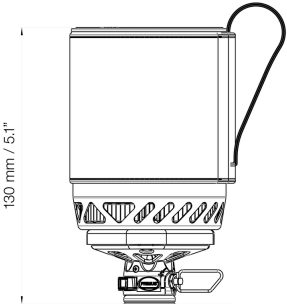

Accessories

-  P737570
Coffee-Tea Press for Lite+
-  P741610
Longspoon Black

Weight	350 g
Power	1500 W
Boiling Time	2:45 (0.5 l) min with PrimeTech Pot
Serving Group Size	1 - 2 People
Fuel Consumption	100 g/h

OMNILITE TI W. BOTTLE & POUCH

ART. NO. P321985



Accessories



P740390
PrimeTech
Pot Set 2.3L



P737937
OmniLite Ti
Silencer

Related products



P321988
OmniLite Ti

Weight	230 g
Power	2600 W
Boiling Time	2:40 min with PrimeTech Pot 3:40 min with Regular Pot
Serving Group Size	1 - 2 People
Fuel Consumption	185 g/h

Our lightest multi fuel stove packaged to include a fuel bottle with an ErgoPump™ and a super pouch for convenient travel anywhere.

- Lightweight and packs down for ultimate travel experience
- Ultralight, titanium pot supports
- Fuel-efficient burner; most efficient with Primus PrimeTech Pot with integrated heat exchanger
- Fine control valve for precise flame and heat control
- Can easily be self-serviced
- Travel friendly, works with variety of fuel types including canister gas, white gas, kerosene, diesel and aviation fuel
- Multiple jet nipples included to use with corresponding fuel
- Comes with a fuel bottle (with an ErgoPump™), a multi-tool with a cleaning needle, a foldable windscreen, a heat reflector, and a super pouch
- Primus Expedition Service certified!
- Invented in Sweden, made in Europe. Gas NOT included

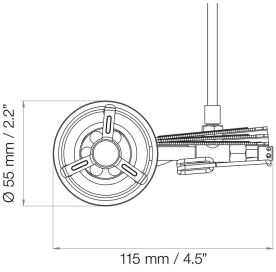
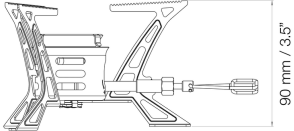
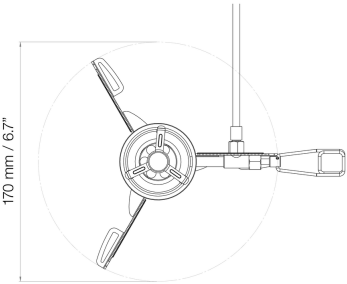

OMNILITE TI

ART. NO. P321988



This ultra-light, titanium, multi fuel stove has incredible flame control and uses multiple fuel options so you can cook anywhere in the world.

- Lightweight and packs down for ultimate travel experience
- Ultralight, titanium pot supports
- Fuel-efficient burner; most efficient with Primus PrimeTech Pot with integrated heat exchanger
- Fine control valve for precise flame and heat control
- Can easily be self-serviced
- Travel friendly, works with variety of fuel types including canister gas, white gas, kerosene, diesel and aviation fuel
- Multiple jet nipples included to use with corresponding fuel
- Comes with an ErgoPump, a multi-tool with a cleaning needle, a foldable windscreen, a heat reflector and a nylon bag
- Primus Expedition Service certified!
- Invented in Sweden, made in Europe. Gas NOT included

Accessories



P740390 PrimeTech Pot Set 2.3L
P737937 OmniLite Ti Silencer

Related products



P321985 OmniLite Ti w. Bottle & Pouch
P321987 OmniLite Ti w. Bottle US

Weight	230 g
Power	2600 W
Boiling Time	2:40 min with PrimeTech Pot 3:40 min with Regular Pot
Serving Group Size	1 - 2 People
Fuel Consumption	185 g/h

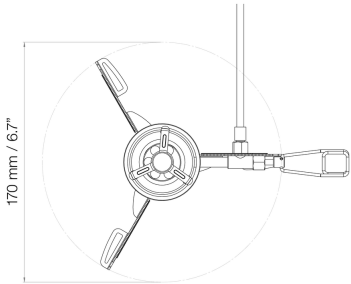
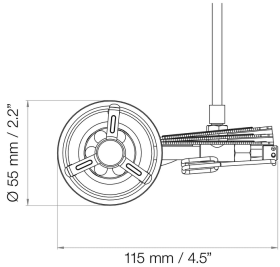
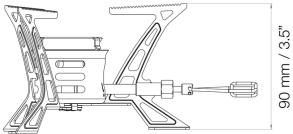

OMNIFUEL II W. BOTTLE & POUCH

ART. NO. P328988



A stove with precise flame control, extremely high heat output, Fuel Bottle and a super pouch provides a complete kit for your travels.

- High output and a wide flame excels at heating larger pots to cook for 1-4 people
- Stainless steel pot supports offer optimal durability
- Fine control valve for precise flame and heat control
- Can easily be self-serviced
- Travel friendly, works with variety of fuel types including canister gas, white gas, kerosene, diesel and aviation fuel
- Multiple jet nipples included to use with corresponding fuel and attach directly to the pot supports
- Comes with a fuel bottle (with an ErgoPump™) a multi-tool with a cleaning needle, a foldable windscreen, a heat reflector, and a super pouch
- Primus Expedition Service certified!
- Invented in Sweden, made in Europe
- Gas NOT included

Accessories Related products

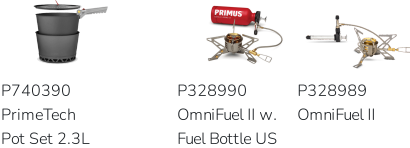

P740390 PrimeTech Pot Set 2.3L P328990 OmniFuel II w. Fuel Bottle US P328989 OmniFuel II

Weight	450 g
Power	3000 W
Boiling Time	2:00 min with PrimeTech Pot 3:10 min with Regular Pot
Serving Group Size	1 - 4 People
Fuel Consumption	215 g/h

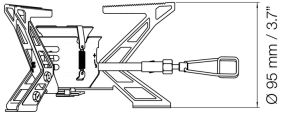
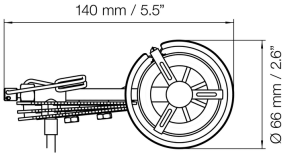
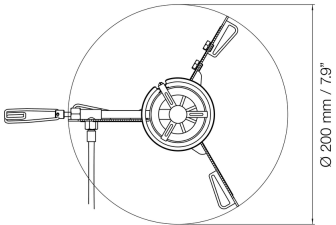

OMNIFUEL II

ART. NO. P328989

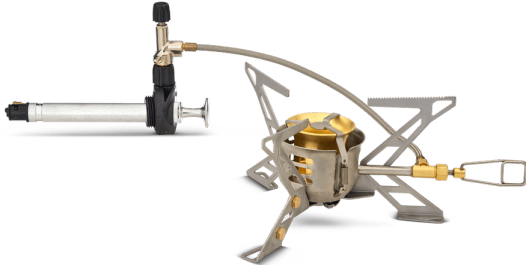

A stove with precise flame control, extremely high heat output, Fuel Bottle and a super pouch provides a complete kit for your travels.

- High output and a wide flame excels at heating larger pots to cook for 1-4 people
- Stainless steel pot supports offer optimal durability
- Fine control valve for precise flame and heat control
- Can easily be self-serviced
- Travel friendly, works with variety of fuel types including canister gas, white gas, kerosene, diesel and aviation fuel
- Multiple jet nipples included to use with corresponding fuel and attach directly to the pot supports
- Primus Expedition Service certified!
- Invented in Sweden, made in Europe
- Gas NOT included

Accessories Related products



P740390
PrimeTech
Pot Set 2.3L



P328988
OmniFuel II w.
Bottle &
Pouch



P328990
OmniFuel II w.
Fuel Bottle US

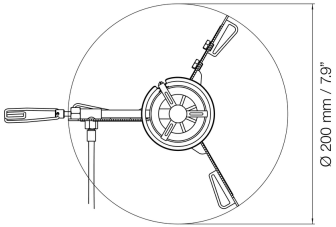

Weight	350 g
Power	3000 W
Boiling Time	2:00 min with PrimeTech Pot 3:10 min with Regular Pot
Serving Group Size	1 - 4 People
Fuel Consumption	215 g/h

MULTIFUEL III

ART. NO. P328896



Accessories



P740390
PrimeTech
Pot Set 2.3L

Weight	373 g
Power	2700 W
Boiling Time	3:10 min with PrimeTech Pot 4:30 min with Regular Pot
Serving Group Size	1 - 4 People
Fuel Consumption	190 g/h

A snow melting, water boiling multi fuel stove when simplicity and reliability are paramount.

- Powerful and wide flame excels at heating larger pots to melt snow or boil water
- Stainless steel pot supports offer optimal durability
- Can easily be self-serviced
- Travel friendly, works with variety of fuel types including canister gas, white gas, kerosene, diesel and aviation fuel
- Multiple jet nipples included to use with corresponding fuel and attach directly to the pot supports
- Comes with an ErgoPump, a multi-tool with a cleaning needle, a foldable windscreen, a heat reflector, and a nylon storage bag
- Primus Expedition Service certified!
- Invented in Sweden, made in Europe
- Gas NOT included

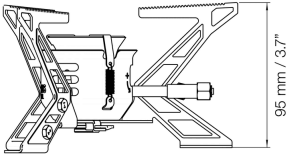
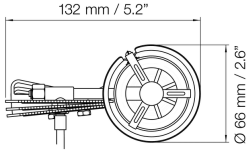
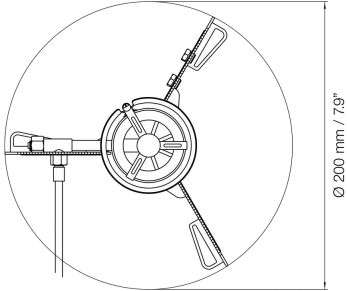

ALIKA STOVE

ART. NO. P350160



Take social cooking outdoors to the next level with a traditional stove with a removable lid, inspired by gathering around campfires.

- Large cooking surface can easily handle 28 cm pots
- Streamlined and compact for easy traveling
- Two unique sized burners provide different flame options, allowing you to cook multiple pots or pans at different temperatures
- Removable lid ensures the stove can be used 360°, and oak laths on lid double as a hot plate when disconnected
- Durable powder coated steel lid and base hold up to years of use while the aluminum sides lighten the load
- Designed to be carried with a lightweight and flexible webbing handle
- Piezo ignition, no lighter required
- Spring-action locking mechanism keeps the regulator in place
- Removable enameled steel pot supports and stainless steel drip tray for easy cleaning
- Invented in Sweden, made in Europé, Gas NOT included

Accessories



P740750 Cooler Backpack
 P738002 CampFire Cookset S.S. Small
 P738007 CampFire Prep Set

Related products



P350161 Alika Stove DE
 P350162 Alika Stove JP
 P350163 Alika Stove US

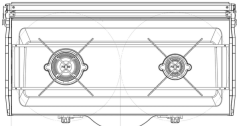

Ø 280 mm / 11.0"

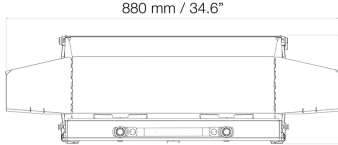

880 mm / 34.6"

285 mm / 11.2"

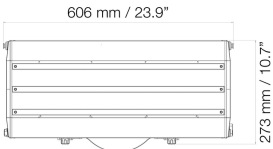

606 mm / 23.9"

273 mm / 10.7"

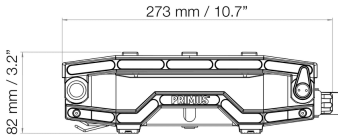

273 mm / 10.7"

82 mm / 3.2"

Weight	4700 g
Power	3000 / 3900 W
Boiling Time	4:20 min with Regular Pot
Serving Group Size	1 - 10 People
Fuel Consumption	280 g/h

ALIKA STOVE DE

ART. NO. P350161



Take social cooking outdoors to the next level with a traditional stove with a removable lid, inspired by gathering around campfires. VERSION FOR GERMAN MARKET.

- Large cooking surface can easily handle 28 cm pots
- Streamlined and compact for easy traveling
- Two unique sized burners provide different flame options, allowing you to cook multiple pots or pans at different temperatures
- Removable lid ensures the stove can be used 360°, and oak laths on lid double as a hot plate when disconnected
- Durable powder coated steel lid and base hold up to years of use while the aluminum sides lighten the load
- Designed to be carried with a lightweight and flexible webbing handle
- Piezo ignition, no lighter required
- Spring-action locking mechanism keeps the regulator in place
- Removable enameled steel pot supports and stainless steel drip tray for easy cleaning
- Comes with adaptor for DIN-combi - German market. Gas NOT included

Related products



P350160 Alika Stove
P350162 Alika Stove JP
P350163 Alika Stove US

Weight	4700 g
Power	3000 / 3900 W
Boiling Time	4:20 min with Regular Pot
Serving Group Size	1 - 10 People
Fuel Consumption	280 g/h

TUPIKE STOVE II

ART. NO. P350154



Deliver a kitchen-like cooking experience at any basecamp with this elegant wood-trimmed 2 burner stove.

- Dual burners allow you to cook multiple pots at different temperatures
- Piezo ignition
- The lid and lockable side windscreens ensure steady heat for cooking, even in windy conditions
- A stainless-steel body, oak laths and brass details provide extra strength and ages beautifully
- Designed to be carried, the wood-trimmed handle locks the stove closed while a spring action locking mechanism keeps the regulator in place
- Removable stainless steel pot supports and stainless steel drip tray for easy cleaning
- Steel legs raise the grill and snap into place to give you more table space, and fold away for transport
- Regulated valve for precise flame and heat control and fuel efficient cooking
- Invented in Sweden, made in Europe
- Gas NOT included

Weight	
Power	
Boiling Time	
Serving Group Size	
Fuel Consumption	

TUPIKE STOVE II DE

ART. NO. P350155



Deliver a kitchen-like cooking experience at any basecamp with this elegant wood-trimmed 2 burner stove.

- Dual burners allow you to cook multiple pots at different temperatures
- Piezo ignition
- The lid and lockable side windscreens ensure steady heat for cooking, even in windy conditions
- A stainless-steel body, oak laths and brass details provide extra strength and ages beautifully
- Designed to be carried, the wood-trimmed handle locks the stove closed while a spring action locking mechanism keeps the regulator in place
- Removable stainless steel pot supports and stainless steel drip tray for easy cleaning
- Steel legs raise the grill and snap into place to give you more table space, and fold away for transport
- Regulated valve for precise flame and heat control and fuel efficient cooking
- Invented in Sweden, made in Europe
- Gas NOT included

Weight	
Power	
Boiling Time	
Serving Group Size	
Fuel Consumption	

KUCHOMA STOVE

ART. NO. P440080



Accessories



P741100 Bag for 4400
 P738006 CampFire Cutting Set
 P741200 Skewers 6 pcs
 P440081 Kuchoma Stove US

Related products

Weight	4600 g
Power	2500 W
Boiling Time	
Serving Group Size	1 - 10 People
Fuel Consumption	180 g/h

BBQ with friends just about anywhere with this portable and functional gas-powered grill.

- Light, compact, and portable, this grill allows you to BBQ just about anywhere
- Designed to be carried, the wood-trimmed handle locks the stove closed while a spring-action locking mechanism keeps the regulator in place
- Horizontal burner tube distributes heat for even grilling
- Deep hood provides plenty of room for thick steaks while sealing in heat and flavor
- Piezo ignition, no lighter required
- Steel legs raise the grill and snap into place to give you more table space, and fold away for transport
- 1lb propane canister stand included (NorAm market)
- Regulated valve for precise flame and heat control and fuel efficient cooking
- Invented in Sweden, made in Europe. Gas NOT included

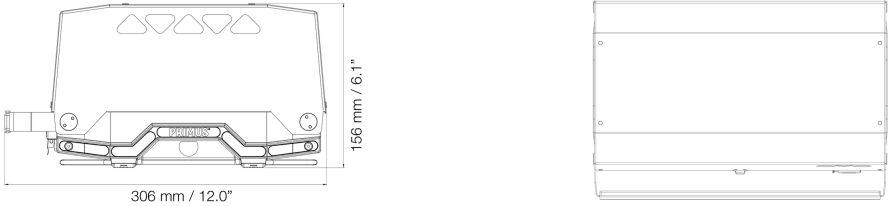

KINJIA STOVE

ART. NO. P350140



Lighter, smaller and more compact than most 2 burner stoves, with uncompromising performance or capacity.

- Light and compact for easy traveling
- Dual burners allow you to cook multiple pots at different temperatures
- Designed to be carried, the wood-trimmed handle locks the stove closed while a spring-action locking mechanism keeps the regulator in place
- Removable stainless steel pot supports and stainless steel drip tray for easy cleaning
- Regulated valve for precise flame and heat control and fuel efficient cooking
- Invented in Sweden, made in Europe
- Gas NOT included

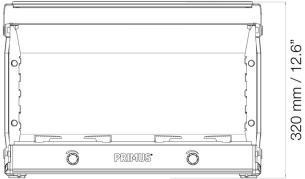

Accessories

Related products

- P741190 Bag for Tupike & Kinjia
- P738001 CampFire Cookset S.S. Large
- P738018 CampFire Griddle plate

- P350141 Kinjia Stove JP
- P350142 Kinjia Stove US

Weight	3700 g
Power	2 x 3000 W
Boiling Time	4:20 min with Regular Pot
Serving Group Size	1 - 10 People
Fuel Consumption	215 g/h

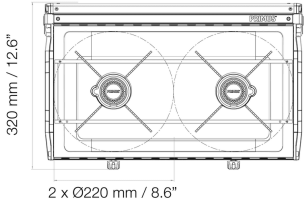
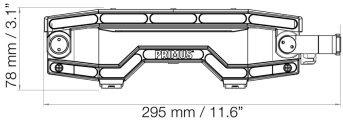

ATLE II

ART. NO. P329083



Feed your family at the campground with this robust 2 burner camping stove.

- Dual burners to cook multiple pots at different temperatures
- Can easily hold heavy pots to cook for a group
- Piezo ignition, no lighter required
- The lid and side windscreens ensure steady heat for cooking, even in windy conditions
- Locks closed with integrated carrying handle for easy transport
- Connects to a refillable propane cylinder (with M14x1.5-connections) with the additional hose and regulator that are included
- Regulated valve for precise flame and heat control and fuel efficient cooking
- Gas NOT included

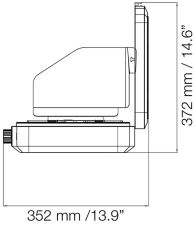
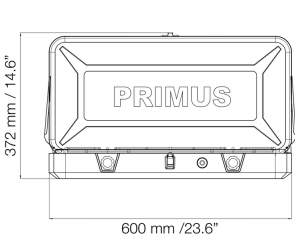

Accessories

- P738002 CampFire Cookset S.S. Small
- P738006 CampFire Cutting Set

Related products

- P329286 Profile DUO US
- P329086 Profile US

Weight	4900 g
Power	2 x 3360 W
Boiling Time	3:00 min with Regular Pot
Serving Group Size	1 - 10 People
Fuel Consumption	240 g/h

MOJA STOVE

ART. NO. P350170



For the times when one extra burner would be nice or is just enough, the Moja Single burner stove is the perfect solution.

- Streamlined, light and compact single burner stove for easy transport
- Removable lid ensures the stove can be used 360°, and holds larger pots
- Durable powder coated steel lid and base hold up to years of use while the aluminum sides lighten the load
- Designed to be carried, the wood-trimmed handle locks the stove closed while a spring-action locking mechanism keeps the regulator in place
- Removable enameled steel pot supports and stainless steel drip tray for easy cleaning
- Invented in Sweden, made in Europe
- Gas NOT included

Accessories

- P738002 CampFire Cookset S.S. Small
- P740810 CampFire Bowl Stainless w. Lid

Related products

- P350171 Moja Stove DE
- P350172 Moja Stove JP
- P350173 Moja Stove US

Weight	2300 g
Power	3000 W
Boiling Time	4:20 min with Regular Pot
Serving Group Size	1 - 4 People
Fuel Consumption	215 g/h

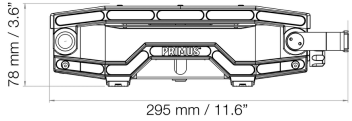
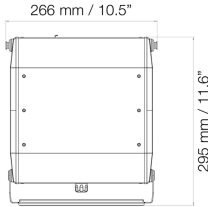
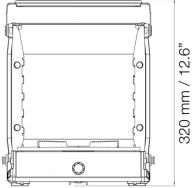
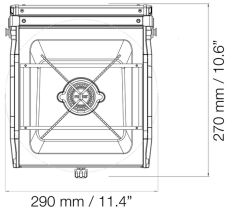

MOJA STOVE DE

ART. NO. P350171



For the times when one extra burner would be nice or is just enough, the Moja Single burner stove is the perfect solution. VERSION FOR GERMAN MARKET

- Streamlined, light and compact single burner stove for easy transport
- Removable lid ensures the stove can be used 360°, and holds larger pots
- Durable powder coated steel lid and base hold up to years of use while the aluminum sides lighten the load
- Designed to be carried, the wood-trimmed handle locks the stove closed while a spring-action locking mechanism keeps the regulator in place
- Removable enameled steel pot supports and stainless steel drip tray for easy cleaning
- Invented in Sweden, made in Europe
- Comes with adaptor for DIN-combi - German market.
- Gas NOT included

Related products



P350170 Moja Stove
P350172 Moja Stove JP
P350173 Moja Stove US

Weight	2300 g
Power	3000 W
Boiling Time	4:20 min with Regular Pot
Serving Group Size	1 - 4 People
Fuel Consumption	215 g/h

MICRON LANTERN GLASS

ART. NO. P221363



A rugged and lightweight lantern to illuminate any backpacking adventure.

- Attaches directly to the gas canister , quick and easy to set up
- Rugged and lightweight for safe travel
- Adjustable brightness gives off 235 lumens on mesh version and 360 lumens on the frosted glass version
- Piezo ignition, no lighter required
- Runs, silent so you can enjoy the sounds of nature
- Pack-friendly rigid carrying case for Glass Micron or nylon storage sack for Steel Mesh Micron included
- Hanging system and one mantle included
- Invented in Sweden, made in Europe
- Gas NOT included

Accessories Related products



P730800
Mantle (pack
of 3) Lanterns



P221383
Micron
Lantern Steel
Mesh

Weight	155 g
Power	300 W
Boiling Time	4-36h min with Regular Pot
Serving Group Size	
Fuel Consumption	20 g/h

MICRON LANTERN STEEL MESH



ART. NO. P221383



A rugged and lightweight lantern to illuminate any backpacking adventure.

- Attaches directly to the gas canister, quick and easy to set up
- Rugged and lightweight for safe travel
- Adjustable brightness gives off 235 lumens on mesh version and 360 lumens on the frosted glass version
- Piezo ignition, no lighter required
- Runs, silent so you can enjoy the sounds of nature
- Pack-friendly rigid carrying case for Glass Micron or nylon storage sack for Steel Mesh Micron included
- Hanging system and one mantle included
- Invented in Sweden, made in Europe
- Gas NOT included

Accessories Related products

-  P730800
Mantle (pack of 3) Lanterns
-  P221363
Micron Lantern Glass

Weight	118 g
Power	300 W
Boiling Time	
Serving Group Size	
Fuel Consumption	20 g/h

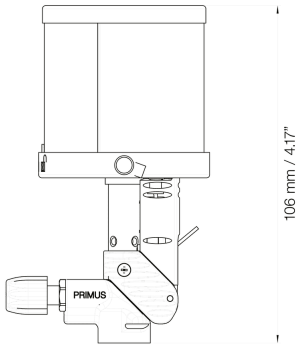
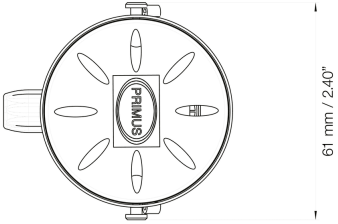

EASYLIGHT DUO

ART. NO. P224543



Compact lantern with a classic look and rounded glass for maximum illumination.

- Attaches directly to the gas canister quick and easy to set up
- Rounded glass and 490 lumens ensures maximum illumination and is adjustable for appropriate ambiance
- Frosted glass for a pleatruw warm light
- Patented burner is quiet so you can enjoy the sounds of nature
- Piezo ignition for fast and easy light; no lighter required
- Hanging system, pack-friendly durable plastic carrying case and one mantle included
- Available in Duo, fitting both threaded (Lindal) and non-threaded canister valves
- Invented in Sweden, made in Europe
- Gas NOT included

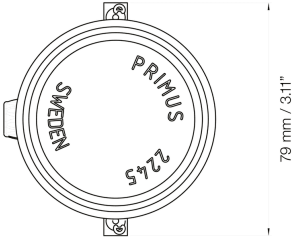
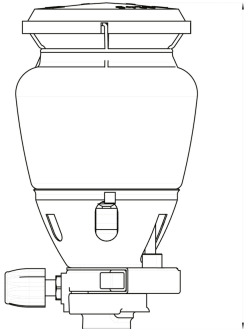

Accessories Related products

 P730800
 Mantle (pack
 of 3) Lanterns

 P224583
 EasyLight

Weight	203 g
Power	300 W
Boiling Time	
Serving Group Size	
Fuel Consumption	20 g/h

EASYLIGHT

ART. NO. P224583



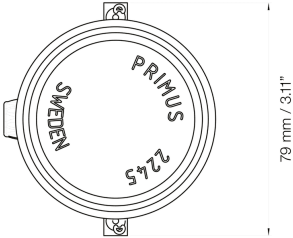
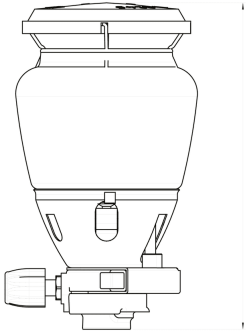

Compact lantern with a classic look and rounded glass for maximum illumination.

- Attaches directly to the gas canister quick and easy to set up
- Rounded glass and 490 lumens ensures maximum illumination and is adjustable for appropriate ambiance
- Frosted glass for a pleatruue warm light
- Patented burner is quiet so you can enjoy the sounds of nature
- Piezo ignition for fast and easy light; no lighter required
- Hanging system, pack-friendly durable plastic carrying case and one mantle included
- Available in Duo, fitting both threaded (Lindal) and non-threaded canister valves
- Invented in Sweden, made in Europe
- Gas NOT included



Accessories

-  P730800 Mantle (pack of 3) Lanterns
-  P733307 PowerLighter III Black

Related products

-  P224543 EasyLight Duo

Weight	187 g
Power	300 W
Boiling Time	
Serving Group Size	
Fuel Consumption	20 g/h

KINJIA STOVE US

ART. NO. P350142



Lighter, smaller and more compact than most 2 burner stoves, with uncompromising performance or capacity.

- Light and compact for easy traveling
- Dual burners allow you to cook multiple pots at different temperatures
- Designed to be carried, the wood-trimmed handle locks the stove closed while a spring-action locking mechanism keeps the regulator in place
- Removable stainless steel pot supports and stainless steel drip tray for easy cleaning
- Regulated valve for precise flame and heat control and fuel efficient cooking
- Invented in Sweden, made in Europe
- Gas NOT included

Accessories

Related products



- P741190 Bag for Tupike & Kinjia
- P738001 CampFire Cookset S.S. Large
- P738018 CampFire Griddle plate

Weight	3700 g
Power	2 x 3000 W
Boiling Time	4:20 min with Regular Pot
Serving Group Size	1 - 10 People
Fuel Consumption	215 g/h

PROFILE US

ART. NO. P329086



Feed your family at the campground with this robust 2 burner camping stove.

- Dual burners to cook multiple pots at different temperatures
- Can easily hold heavy pots to cook for a group
- Piezo ignition, no lighter required
- The lid and side windscreens ensure steady heat for cooking, even in windy conditions
- Locks closed with integrated carrying handle for easy transport
- Connects to a propane cylinder
- Regulated valve for precise flame and heat control and fuel efficient cooking
- Gas NOT included

Weight	4900 g
Power	2 x 3360 W
Boiling Time	3:00 min with Regular Pot
Serving Group Size	1 - 10 People
Fuel Consumption	240 g/h

MOJA STOVE US

ART. NO. P350173



For the times when one extra burner would be nice or is just enough, the Moja Single burner stove is the perfect solution.

- Streamlined, light and compact single burner stove for easy transport
- Removable lid ensures the stove can be used 360°, and holds larger pots
- Durable powder coated steel lid and base hold up to years of use while the aluminum sides lighten the load
- Designed to be carried, the wood-trimmed handle locks the stove closed while a spring-action locking mechanism keeps the regulator in place
- Removable enameled steel pot supports and stainless steel drip tray for easy cleaning
- Invented in Sweden, made in Europe
- Gas NOT included

Related products

Weight	2300 g
Power	3000 W
Boiling Time	4:20 min with Regular Pot
Serving Group Size	1 - 4 People
Fuel Consumption	215 g/h

CLASSIC TRAIL STOVE US

ART. NO. P224383



Robust, reliable, and always ready to use, this sit-on-top stove offers a wide flame great for larger pots.

- Robust and durable with no folding parts, this stove is incredibly easy to use and can be passed down for generations
- Wide flame excels at heating larger pots to cook for 1-3 people
- Static 4-point pot supports offer extra stability and wind resistance while comfortably holding a variety of pot sizes
- Gas NOT included

Related products

Weight	227 g
Power	2800 W
Boiling Time	3:30 min with Regular Pot
Serving Group Size	1 - 3 People
Fuel Consumption	200 g/h

OMNIFUEL II W. FUEL BOTTLE US

ART. NO. P328990



A stove with precise flame control, extremely high heat output, Fuel Bottle and a super pouch provides a complete kit for your travels.

- High output and a wide flame excels at heating larger pots to cook for 1-4 people
- Stainless steel pot supports offer optimal durability
- Fine control valve for precise flame and heat control
- Can easily be self-serviced
- Travel friendly, works with variety of fuel types including canister gas, white gas, kerosene, diesel and aviation fuel
- Multiple jet nipples included to use with corresponding fuel and attach directly to the pot supports
- Comes with a fuel bottle (with an ErgoPump™) a multi-tool with a cleaning needle, a foldable windscreen, a heat reflector, and a super pouch
- Primus Expedition Service certified!
- Invented in Sweden, made in Europe
- Gas NOT included

Related products

Weight	450 g
Power	3000 W
Boiling Time	2:00 min with PrimeTech Pot 3:10 min with Regular Pot
Serving Group Size	1 - 4 People
Fuel Consumption	215 g/h

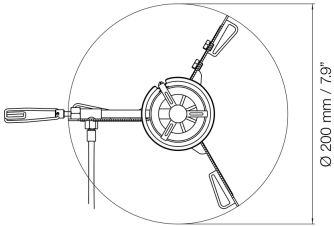
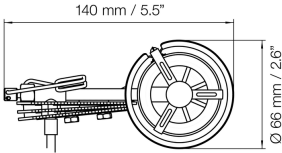
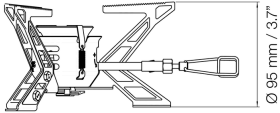

TUPIKE STOVE II JP

ART. NO. P350157



Deliver a kitchen-like cooking experience at any basecamp with this elegant wood-trimmed 2 burner stove.

- Dual burners allow you to cook multiple pots at different temperatures
- Piezo ignition
- The lid and lockable side windscreens ensure steady heat for cooking, even in windy conditions
- A stainless-steel body, oak laths and brass details provide extra strength and ages beautifully
- Designed to be carried, the wood-trimmed handle locks the stove closed while a spring action locking mechanism keeps the regulator in place
- Removable stainless steel pot supports and stainless steel drip tray for easy cleaning
- Steel legs raise the grill and snap into place to give you more table space, and fold away for transport
- Regulated valve for precise flame and heat control and fuel efficient cooking
- Invented in Sweden, made in Europe
- Gas NOT included

Weight	
Power	
Boiling Time	
Serving Group Size	
Fuel Consumption	

TUPIKE STOVE II US

ART. NO. P350156



Deliver a kitchen-like cooking experience at any basecamp with this elegant wood-trimmed 2 burner stove.

- Dual burners allow you to cook multiple pots at different temperatures
- Piezo ignition
- The lid and lockable side windscreens ensure steady heat for cooking, even in windy conditions
- A stainless-steel body, oak laths and brass details provide extra strength and ages beautifully
- Designed to be carried, the wood-trimmed handle locks the stove closed while a spring action locking mechanism keeps the regulator in place
- Removable stainless steel pot supports and stainless steel drip tray for easy cleaning
- Steel legs raise the grill and snap into place to give you more table space, and fold away for transport
- Regulated valve for precise flame and heat control and fuel efficient cooking
- Invented in Sweden, made in Europe
- Gas NOT included

Weight	
Power	
Boiling Time	
Serving Group Size	
Fuel Consumption	



OPEN FIRE



OPEN FIRE

KAMOTO OPENFIRE PIT LARGE

ART. NO. P738061



This portable fire pit offers leave-no-trace campfires and open fire cooking anywhere.

- Burn wood or charcoal
- Powder-coated steel and stainless steel materials to handle years of use
- Windshields and air inlet tray for reliable and safe cooking
- Grill grate and secure storage strap included
- Can be combined with Open Fire Pan and pots and pans from Primus made in stainless steel
- Invented in Sweden

Accessories



P738062
OpenFire
Pack Sack



P738001
CampFire
Cookset S.S.
Large

Related products



P738060
Kamoto
OpenFire Pit

OPEN FIRE

KAMOTO OPENFIRE PIT

ART. NO. P738060

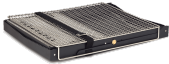

This portable fire pit offers leave-no-trace campfires and open fire cooking anywhere.

- Burn wood or charcoal
- Powder-coated steel and stainless steel materials to handle years of use
- Windshields and air inlet tray for reliable and safe cooking
- Grill grate and secure storage strap included
- Can be combined with Open Fire Pan and pots and pans from Primus made in stainless steel
- Invented in Sweden

Accessories



P738062
OpenFire
Pack Sack



P738002
CampFire
Cookset S.S.
Small



P738061
Kamoto
OpenFire Pit
Large

Related products

OPEN FIRE

IGNITION STEEL LARGE BLACK

ART. NO. P741250



The most reliable way of starting a fire or lighting your stove in all weather conditions.

- Water-resistant and works in wet conditions – even rain and snow
- Water-resistant and works in wet conditions – even rain and snow
- The steel parts are protected in the integrated case
- Reflective lanyard for carrying convenience
- Spark emitted has a temperature of 5400 °C and will strike thousands of times
- Invented in Sweden
- Available in two sizes and multiple colors

Related products



P741260
Ignition Steel
Large Barn
red

OPEN FIRE

IGNITION STEEL SMALL BLACK

ART. NO. P741210



The most reliable way of starting a fire or lighting your stove in all weather conditions.

- Water-resistant and works in wet conditions – even rain and snow
- The steel parts are protected in the integrated case
- Reflective lanyard for carrying convenience
- Spark emitted has a temperature of 5400 °C and will strike thousands of times
- Invented in Sweden
- Available in two sizes and multiple colors

Related products



P741220
Ignition Steel
Small Barn
red



P741240
Ignition Steel
Small
Tangerine

OPEN FIRE

IGNITION STEEL LARGE BARN RED

ART. NO. P741260



The most reliable way of starting a fire or lighting your stove in all weather conditions.

- Water-resistant and works in wet conditions – even rain and snow
- The steel parts are protected in the integrated case
- Reflective lanyard for carrying convenience
- Spark emitted has a temperature of 5400 °C and will strike thousands of times
- Invented in Sweden
- Available in two sizes and multiple colors

Related products

OPEN FIRE

IGNITION STEEL SMALL BARN RED

ART. NO. P741220



The most reliable way of starting a fire or lighting your stove in all weather conditions.

- Water-resistant and works in wet conditions – even rain and snow
- The steel parts are protected in the integrated case
- Reflective lanyard for carrying convenience
- Spark emitted has a temperature of 5400 °C and will strike thousands of times
- Invented in Sweden
- Available in two sizes and multiple colors
- Available in two sizes and multiple colors



COOKWARE



CAMPFIRE KETTLE 0.9L STAINLESS STEEL

ART. NO. P743680



A perfect addition to any campground, this durable stainless steel kettle is ideal for morning pour-overs and campfire tea times.

- Durable stainless steel kettle perfect for morning pour overs and campfire tea time
- Made of food grade 18/8 stainless steel that doesn't impart or retain flavor
- Copper base for optimum heat distribution
- Can be combined with almost any stove/burner
- Removable lid for easy filling and cleaning
- Narrow pour spout for an easy and clean pour
- Packing up is a breeze with a handle that folds down
- Designed in Sweden

Related products



P743810
Campfire
Kettle 1.5L
Stainless
Steel

PREPPING BOWL W. LID 1.0L STAINLESS STEEL

ART. NO. P743670



Prep, serve, or share favorite camp oatmeal and stews with this small lightweight bowl complete with a sealable plastic lid.

- Made of food grade 18/8 stainless steel that doesn't impart or retain flavor
- Thin construction makes for an elegant and lightweight bowl
- Use for prepping, serving, or to store leftovers with the BPA Free, snug-fitting plastic lid
- The tapered shape makes it stackable for easier packing

Related products



P743660
Prepping
Bowl w. Lid
0.6L Stainless
Steel

PREPPING BOWL W. LID 0.6L STAINLESS STEEL

ART. NO. P743660



Prep, serve, or share favorite camp oatmeal and stews with this small lightweight bowl complete with a sealable plastic lid.

- Made of food grade 18/8 stainless steel that doesn't impart or retain flavor
- Thin construction makes for an elegant and lightweight bowl
- Use for prepping, serving, or to store leftovers with the BPA Free, snug-fitting plastic lid
- The tapered shape makes it stackable for easier packing

Related products



P743670
Prepping
Bowl w. Lid
1.0L Stainless
Steel

ULTI POT 2.5

ART. NO. P743070



Quickly boil water or create gourmet backcountry meals in the harshest of environments with this heat-efficient pot.

- Hard-anodized aluminum pot with pour spout has integrated heat exchanger.
- Sturdy handle allows you to easily hold the pot or folds over the lid to lock the stove system together in a impact protected package.
- Hard-anodized aluminum pot lid with sturdy handle.
- Comes in mutiple sizes that can nest together tightly for rattle-free packing.

Related products



P743050
Ulti Pot 1.0



P743060
Ulti Pot 1.7

ULTI POT 1.7

ART. NO. P743060



Quickly boil water or create gourmet backcountry meals in the harshest of environments with this heat-efficient pot.

- Hard-anodized aluminum pot with pour spout has integrated heat exchanger.
- Sturdy handle allows you to easily hold the pot or folds over the lid to lock the stove system together in a impact protected package.
- Hard-anodized aluminum pot lid with sturdy handle.
- Comes in mutiple sizes that can nest together tightly for rattle-free packing.

Related products



P743050
Ulti Pot 1.0



P743070
Ulti Pot 2.5

ULTI POT 1.0

ART. NO. P743050



Quickly boil water or create gourmet backcountry meals in the harshest of environments with this heat-efficient pot.

- Hard-anodized aluminum pot with pour spout has integrated heat exchanger.
- Sturdy handle allows you to easily hold the pot or folds over the lid to lock the stove system together in a impact protected package.
- Hard-anodized aluminum pot lid with sturdy handle.
- Comes in mutiple sizes that can nest together tightly for rattle-free packing.

Related products



P743060
Ulti Pot 1.7



P743070
Ulti Pot 2.5

ESSENTIAL POT SET 2.3L

ART. NO. P740300



A simple lightweight, anodized aluminum all-in-one pot and pan set made to feed the family and friends on outdoor adventures.

- Lightweight pots and pan for simple cooking in one compact package
- Can be combined with almost any stove/burner
- Includes two anodized aluminum pots that nest into each other for easy packing
- Frying pan/pot lid with ceramic, non-stick coating works as a skillet or keeps heat in while boiling water
- Removable Pot Gripper handles hot pots and pans with ease
- Comes with a nylon storage bag
- Invented in Sweden, made in Europe
- Gas and stove NOT included

Related products



P740290
Essential Pot
Set 1.3L

ESSENTIAL POT SET 1.3L

ART. NO. P740290



A simple lightweight, anodized aluminum all-in-one pot and pan set made to feed the family and friends on outdoor adventures.

- Lightweight pots and pan for simple cooking in one compact package
- Can be combined with almost any stove/burner
- Includes two anodized aluminum pots that nest into each other for easy packing
- Frying pan/pot lid with ceramic, non-stick coating works as a skillet or keeps heat in while boiling water
- Removable Pot Gripper handles hot pots and pans with ease
- Comes with a nylon storage bag
- Invented in Sweden, made in Europe
- Gas and stove NOT included

Related products



P740300
Essential Pot
Set 2.3L

LITECH POT SET 2.3L

ART. NO. P740320



A lightweight and durable pot set that can cook gourmet meals with a non-stick ceramic coating and a colander lid.

- Lightweight and compact pot set for backcountry
- Can be combined with almost any stove/burner
- Two hard-anodized aluminum pots with a ceramic, non-stick coating
- Lightweight plastic lid comes with silicone handle and works as a strainer
- Removable Pot Gripper handles hot pots with ease
- Nests together tightly for rattle-free packing
- Comes with a storage bag
- Invented in Sweden
- Gas and stove NOT included

Related products



P740310
LiTech Pot Set
1.3L

LITECH POT SET 1.3L

ART. NO. P740310



A lightweight and durable pot set that can cook gourmet meals with a non-stick ceramic coating and a colander lid.

- Lightweight and compact pot set for backcountry
- Can be combined with almost any stove/burner
- Two hard-anodized aluminum pots with a ceramic, non-stick coating
- Lightweight plastic lid comes with silicone handle and works as a strainer
- Removable Pot Gripper handles hot pots with ease
- Nests together tightly for rattle-free packing
- Comes with a storage bag
- Invented in Sweden
- Gas and stove NOT included

Related products



P740320
LiTech Pot Set
2.3L

PRIMETECH POT SET 2.3L

ART. NO. P740390



Create gourmet meals with this heat-efficient two pot set that can cook pretty much anything with a non-stick ceramic coating and a colander lid.

- Everything you need for backcountry gourmet cooking in one compact package
- Can be combined with almost any stove/burner, but is most fuel efficient with the PrimeTech Stove
- Two lightweight hard-anodized aluminum pots, one with integrated heat exchanger and ceramic, non-stick coating
- Lightweight plastic lid comes with silicone handle and works as a strainer
- Removable Crimp Pot Gripper handles hot pots and pans with ease
- Nests together tightly for rattle-free packing
- Comes with a padded/insulated storage bag
- Invented in Sweden
- Gas and stove NOT included

Related products



P740380
PrimeTech
Pot Set 1.3L

PRIMETECH POT SET 1.3L

ART. NO. P740380



Create gourmet meals with this heat-efficient two pot set that can cook pretty much anything with a non-stick ceramic coating and a colander lid.

- Everything you need for backcountry gourmet cooking in one compact package
- Can be combined with almost any stove/burner, but is most fuel efficient with the PrimeTech Stove
- Two lightweight hard-anodized aluminum pots, one with integrated heat exchanger and ceramic, non-stick coating
- Lightweight plastic lid comes with silicone handle and works as a strainer
- Removable Crimp Pot Gripper handles hot pots and pans with ease
- Nests together tightly for rattle-free packing
- Comes with a padded/insulated storage bag
- Invented in Sweden
- Gas and stove NOT included

Related products



P740390
PrimeTech
Pot Set 2.3L

TREK POT 1.0L

ART. NO. P741410



These hard-anodized aluminum pots are lightweight, heat quickly and offer a durable finish that are corrosion-resistant. The Trek Pots are a perfect solution for backcountry meals. Available in two sizes or as a set.

- Hard anodized aluminum pot conducts heat efficiently and effectively
- Ceramic Nonstick-coating for easy cooking
- Thicker bottom for a more even temperature
- Frying pan in hard-anodized aluminum and ceramic Nonstick-coating doubles as a lid
- Spiral pattern on base ensures optimum heat transfer and adds additional grip on stove pot supports
- 2 adjustable and removable handles allow you to cook or transport pots with ease
- Comes with a mesh storage bag
- Fits Essential Trail Stove connected to a 230g canister
- Invented in Sweden
- Gas and stove NOT included

Related products



P741420
Trek Pot SET

TREK POT 0.6L

ART. NO. P741400

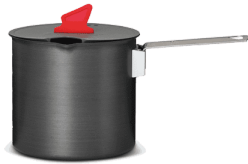

These hard-anodized aluminum pots are lightweight, heat quickly and offer a durable finish that are corrosion-resistant. The Trek Pots are a perfect solution for backcountry meals. Available in two sizes or as a set.

- Hard-anodized aluminum pot conducts heat efficiently and effectively
- Ceramic Nonstick-coating for easy cooking
- Thicker bottom for a more even temperature
- Spiral pattern on base ensures optimum heat transfer and adds additional grip on stove pot supports
- Lightweight plastic lid with silicon handles also works as a strainer
- Adjustable and removable handle allows you to cook or transport pots with ease
- Comes with a mesh storage bag
- Fits inside the Trek Pot 1.0L
- Invented in Sweden
- Gas and stove NOT included

Related products



P741420
Trek Pot SET

ESSENTIAL TREK POT 1.0L

ART. NO. P741440



These anodized aluminum pots are lightweight and are the perfect backpacking pots for efficient meals in the backcountry. Available in two sizes or as a set.

- Anodized aluminum pot conducts heat efficiently and effectively
- Perfect for lightweight and simple cooking
- Frying pan/pot lid with ceramic nonstick-coating works as a skillet or keeps heat in while boiling water
- Spiral pattern on base ensures optimum heat transfer and adds additional grip on stove pot supports
- 2 adjustable and removable handles allow you to cook or transport pots with ease
- Comes with a mesh storage bag
- Fits Essential Trail Stove connected to a 230g canister
- Invented in Sweden
- Gas and stove NOT included

Related products



P741450
Essential Trek
Pot SET

ESSENTIAL TREK POT 0.6L

ART. NO. P741430



These anodized aluminum pots are lightweight and are the perfect backpacking pots for efficient meals in the backcountry. Available in two sizes or as a set.

- Anodized aluminum pot conducts heat efficiently and effectively
- Perfect for small portions
- Lightweight plastic lid with silicon handles also works as a strainer
- Spiral pattern on base ensures optimum heat transfer and ads
- Adjustable and removable handle allows you to cook or transport pots with ease
- Comes with a mesh storage bag
- Fits inside the Essential Trek Pot 1.0L
- Invented in Sweden
- Gas and stove NOT included

Related products



P741450
Essential Trek
Pot SET

ESSENTIAL TREK POT SET

ART. NO. P741450



These anodized aluminum pots are lightweight and are the perfect backpacking pots for efficient meals in the backcountry. Available in two sizes or as a set.

- A set of one 1-litre and one 0.6 litre anodized aluminum pots that conducts heat efficiently and effectively
- Frying pan with nonstick-coating works both as a skillet or as lid for the 1-litre pot
- Lightweight plastic lid for the 0.6 litre pot comes with silicon handle and also works as a strainer
- Spiral pattern on pot base ensures optimum heat transfer and adds additional grip on stove pot supports
- 3 adjustable and removable handles allows you to cook or transport pots with ease
- Comes with a mesh storage bag
- Nests together tightly for rattle-free packing
- Invented in Sweden
- Gas and stove NOT included

LITE XL POT 1.0 L (34 Z)

ART. NO. P741500



A larger fuel-efficient pot to cook double the quantity of the Lite or Lite Plus Stove Systems.

- Larger fuel-efficient pot system locks securely to any Primus Laminar Flow burner (Lite Plus or Lite models)
- 1-liter hard-anodized aluminum pot with pour spout has integrated heat exchanger
- Adjustable and removable handle allows you to cook or transport pots with ease
- Cork-lined insulated pot sleeve made from G-1000 ECO Lite fabric
- Bio-based plastic pot lid doubles as a cup
- Coffee/Tea Press for Litech Trek Kettle (not included) makes up to 1.0L of your favorite hot beverage on-the-go
- Invented in Sweden
- Gas and stove NOT included

Accessories



P734520
Coffee-Tea
Press for
731722,
356011

CAMPFIRE KETTLE 1.5L STAINLESS STEEL

ART. NO. P743810



A perfect addition to any campground, this durable stainless steel kettle is ideal for morning pour-overs and campfire tea times.

- Durable stainless steel kettle perfect for morning pour overs and campfire tea time
- Made of food grade 18/8 stainless steel that doesn't impart or retain flavor
- Copper base for optimum heat distribution
- Can be combined with almost any stove/burner
- Removable lid for easy filling and cleaning
- Narrow pour spout for an easy and clean pour
- Packing up is a breeze with a handle that folds down
- Designed in Sweden

Related products



P743680
Campfire
Kettle 0.9L
Stainless
Steel

PREPARATION

TOASTER

ART. NO. P720661



Up the camp cooking game with this lightweight and durable bread toaster. Toast on almost any camp stove and dish up avocado toast.

- Can be combined with almost any stove/burner
- Mesh net evenly distributes heat across the slice of bread
- When finished cooking, simply collapse the toaster and fold the handle in for safe and compact transport
- Invented in Sweden

PREPARATION

LITECH COFFEE & TEA KETTLE 1.5L

ART. NO. P733810



A lightweight yet durable hard-anodized coffee kettle perfect for morning pour-overs.

- Lightweight hard-anodized aluminum kettle perfect for morning pour overs
- Can be combined with almost any stove/burner
- Removable lid for easy filling and cleaning
- Narrow pour spout for an easy and clean pour
- Packing up is a breeze with a handle that folds down
- Cotton storage bag included
- Invented in Sweden

Related products



P731701
LiTech Coffee
& Tea Kettle
0.9L

PREPARATION

LITECH COFFEE & TEA KETTLE 0.9L

ART. NO. P731701



A lightweight yet durable hard-anodized coffee kettle perfect for morning pour-overs.

- Lightweight hard-anodized aluminum kettle perfect for morning pour overs
- Can be combined with almost any stove/burner
- Removable lid for easy filling and cleaning
- Narrow pour spout for an easy and clean pour
- Packing up is a breeze with a handle that folds down
- Cotton storage bag included
- Invented in Sweden

Related products



P733810
LiTech Coffee
& Tea Kettle
1.5L

PREPARATION

LITECH TREK KETTLE

ART. NO. P731722



This 1.0L hard-anodized aluminum pot with a frying pan lid with multi-layer, non-stick coating are lightweight and is the perfect backpacking pot & pan set for off the beaten path adventures.

- Perfect for lightweight backpacking and a variety of cooking methods
- Can be combined with almost any stove/burner
- Hard-anodized aluminum pot conducts heat efficiently and effectively
- Multi-layer, non-stick coating for easy cooking
- Frying pan in hard-anodized aluminum and ceramic nonstick-coating doubles as a lid
- Foldable handles allow you to cook or transport with ease
- Comes with a mesh storage bag
- Fits Essential Trail Stove connected to a 230g canister
- Coffee/Tea Press for Litech Trek Kettle (not included) makes up to 1.0L of your favorite hot beverage on-the-go
- Invented in Sweden, gas and stove NOT included

Accessories

PREPARATION

POT GRIPPER

ART. NO. P731760



Lightweight Pot Gripper allows you to handle hot pots anywhere with ease.

- Lightweight pot gripper makes it both easier and safer to cook in the outdoors
- Can be combined with almost any pot
- Invented in Sweden

PREPARATION

MEAL SET BLACK

ART. NO. P734001



The perfect all-in-one serving and travelling set with everything you need to bring your favorite meal to life.

- Complete BPA free eight-piece meal set
- Deep plate/lid and bowl/base with raised sides to keep everything in place
- Spice jar with three compartments
- Small container that can be used for liquids
- Secondary storage container with tight-fitting lid
- All-in-one cutting board, grater, colander, and knife
- Outdoor cup and folding spork
- Available in multiple colors

Related products



P734000
Meal Set Red



P734002
Meal Set
Green

PREPARATION

COFFEE-TEA PRESS FOR 731722, 356011

ART. NO. P734520



Enjoy a cup of delicious freshly French pressed/ presso-kaffe coffee or tea outdoors.

- French press or presso-faffe style coffee in the backcountry
- Press unscrews to pack flat
- Works with multiple Primus brand pots
- Invented in Sweden

Accessories



P731722
LiTech Trek
Kettle



P356011
Lite XL Piezo

PREPARATION

LITECH FRYING PAN

ART. NO. P737420



The perfect lightweight addition to any backpacking cookset.

- Lightweight hard-anodized aluminum frying pan with non-stick ceramic coating
- Can be combined with almost any stove/burner
- Available in two sizes, 21 cm and 25 cm.
- Packing up is a breeze with a collapsible handle that folds away under the pan
- Cotton storage bag included

Related products



P737430
Litech Frying
Pan Large

PREPARATION

LITECH FRYING PAN LARGE

ART. NO. P737430



The perfect lightweight addition to any backpacking cookset. These pans can fry, sauté, or simmer, just like at home.

- Lightweight hard-anodized aluminum frying pan with non-stick ceramic coating can add extra flavor to your outdoor meal
- Can be combined with almost any stove/burner
- Available in two sizes, 21 cm and 25 cm.
- Packing up is a breeze with a collapsible handle that folds away under the pan
- Cotton storage bag included

Related products



P737420
LiTech Frying
Pan

PREPARATION

COFFEE-TEA PRESS FOR LITE+

ART. NO. P737570



Enjoy a cup of delicious freshly French pressed/ presso-kaffe coffee or tea outdoors.

- French press or presso-faffe style coffee in the backcountry
- Press unscrews to pack flat
- Works with multiple Primus brand pots
- Invented in Sweden

Accessories



P356030
Lite Plus
Stove System
Black

PREPARATION

CAMPFIRE FRYING PAN S.S. 25CM

ART. NO. P738000



Sear, sautéé, blanch,or fry over an open fire or camp stove with these stainless steel frying pans.

- Large 25cm size can cook larger portions with ease
- Durable and constructed with 18/8 stainless steel and finished with an aluminum-clad bottom that ensures even heat distribution
- Packing up is a breeze with a collapsible handle that folds away under the pan
- Cotton storage bag included

Related products



P738003
CampFire
Frying Pan
S.S. 21cm

PREPARATION

CAMPFIRE FRYING PAN S.S. 21CM

ART. NO. P738003



Sear, sautéé, blanch,or fry over an open fire or camp stove with these stainless steel frying pans

- Smaller 21cm size sears, blanches and fries a variety of foods with ease
- Durable and constructed with 18/8 stainless steel and finished with an aluminum-clad bottom that ensures even heat distribution
- Packing up is a breeze with a collapsible handle that folds away under the pan
- Cotton storage bag included

Related products



P738000
CampFire
Frying Pan
S.S. 25cm

PREPARATION

CAMPFIRE COOKSET S.S. LARGE

ART. NO. P738001



A robust stainless steel set of pots and pans for open fire cooking.

- Constructed with 18/8 stainless steel makes it extremely wear and rust resistant
- Stainless-steel lids with a leather tag to make it easy to check the contents while integrated colander strains any camp meal
- Classic 3L stock pot is large enough to feed a family yet small enough to carry with you to the campsite
- Stock Pot metal handle enables the pot to be hung over an open fire and folds down, out of the way during packing
- 1.8L saucepan is large enough to feed a family yet small enough to carry with you to the campsite
- Saucepan metal handles swing open to become a traditional handle and wraps around the pot during packing
- 21cm Frying Pan with an aluminum-clad bottom ensures even heat distribution
- Frying Pan sears, blanches and fries a variety of foods with ease
- Pack up frying pan with a collapsible handle that folds away under the pan
- Easily pack in your cook bin, all items nest together and fit in a cotton storage sack

Related products



P738002
CampFire
Cookset S.S.
Small

PREPARATION

CAMPFIRE COOKSET S.S. SMALL

ART. NO. P738002



A robust stainless steel set of pots and pans for open fire cooking.

- Constructed with 18/8 stainless steel makes it extremely wear and rust resistant
- Stainless-steel lids with a leather tag to make it easy to check the contents while integrated colander strains any camp meal
- 1.8L and 1L saucepans are large enough to feed a family yet small enough to carry with you to the campsite
- Saucepan metal handles swing open to become a traditional handle and wraps around the pot during packing
- 21cm Frying Pan with an aluminum-clad bottom ensures even heat distribution
- Frying Pan sears, blanches and fries a variety of foods with ease
- Pack up frying pan with a collapsible handle that folds away under the pan
- Easily pack in your cook bin, all items nest together and fit in a cotton storage sack

Related products



P738001
CampFire
Cookset S.S.
Large

PREPARATION

CAMPFIRE POT S.S. 5L

ART. NO. P738005



Place this stock pot directly over an open fire or use with a stove for perfectly simmered soups, stews and hearty hot meals.

- Large 5L classic style stock pot feeds your extended family plus your campsite neighbors
- Durable and constructed with 18/8 stainless steel makes it extremely wear and rust resistant
- Stainless-steel lid with a leather tag makes it easy to check the contents while integrated colander strains any camp meal
- Metal handle enables the pot to be hung over an open fire and folds down out of the way during packing
- Cotton storage bag included

Related products



P738004
CampFire Pot
S.S. 3L

PREPARATION

CAMPFIRE POT S.S. 3L

ART. NO. P738004



Place this stock pot directly over an open fire or use with a stove for perfectly simmered soups, stews and hearty hot meals.

- Small 3L classic style stock pot size is large enough to feed a family yet small enough to carry with you to the campsite
- Durable and constructed with 18/8 stainless steel makes it extremely wear and rust resistant
- Stainless-steel lid with a leather tag makes it easy to check the contents while integrated colander strains any camp meal
- Metal handle enables the pot to be hung over an open fire and folds down out of the way during packing
- Cotton storage bag included

Related products



P738005
CampFire Pot
S.S. 5L

PREPARATION

CAMPFIRE CUTTING SET

ART. NO. P738006



A convenient camp knife and cutting board set that makes chopping, slicing, and filleting food in the outdoors a cinch.

- A high-quality, compact, portable and convenient cooking set that makes cutting, chopping and dicing food in the outdoors a breeze
- The 15cm stainless steel knife with an oak wood handle has a flexible blade suitable for chopping, slicing, and filleting
- Durable oak hardwood cutting board, perfect for preparing food with a smooth surface and a natural self-disinfectant effect
- PU-coated G1000 wrap serves as an additional space to prepare and place food on and is coated on the inside for easy cleaning
- Invented in Sweden

PREPARATION

CAMPFIRE PREP SET

ART. NO. P738007



The outdoor camp kitchen “mise en place”– everything in order and in one place.

- Includes a knife, grater, and wooden cooking spoons and utensils, conveniently rolled in a durable wrap
- 12cm stainless steel knife has a flexible blade suitable for chopping, slicing, and filleting Stainless steel grater doubles as a zester to take your outdoor culinary skills to new heights
- Traditional spoon, oversized fork and flat edged scraper fit all your cooking needs and are safe to use with nonstick pans
- PU-coated G1000 cover wrap serves as an additional space to prepare and place food on, includes a pocket for other small accessories, and is coated on the inside for easy cleaning
- Invented in Sweden

PREPARATION

CAMPFIRE KNIFE LARGE

ART. NO. P738009



Designed for the outdoors, the stainless steel blade and oak handle excel in the outdoors and offers excellent slicing, chopping and dicing.

- 15 cm blade in Stainless Steel
- The stainless steel has a flexible blade suitable for chopping, slicing, and filleting
- Durable oak handle offers a natural self-disinfectant effect
- Comes with a durable cover, making transport safe
- Available in 2 sizes

PREPARATION

OPENFIRE SPATULA

ART. NO. P738052



A stainless steel spatula with an extended handle that works in a variety of outdoor cooking situations.

- Made of food-grade 18/8 stainless steel that doesn't impart or retain flavor
- Sturdy yet flexible for great control while cooking
- Durable oak handle offers a natural self-disinfectant effect
- A perfect tool for Primus Openfire Pans or Kamoto Openfire Pit

PREPARATION

CRIMP POTGRIPPER

ART. NO. P740400



The sturdiness of a fixed handle with the flexibility of a traditional pot gripper.

- Locks safely to the pot making it both easier and safer to cook
- Can be combined with almost any pot
- With one simple push, it releases and can be used for other pots
- Invented in Sweden

PREPARATION

FIELDCHIEF KNIFE BLACK

ART. NO. P740410



Designed for the outdoor cooking, the stainless steel blade excels in the outdoors and offers excellent slicing, chopping and dicing.

- 12 cm long blade in stainless steel
- The stainless steel has a flexible blade suitable for chopping, slicing, and filleting
- Comfortable plastic handle
- Comes with a durable cover, making transport safe
- Available in 2 sizes

PREPARATION

FIELDCHIEF POCKET KNIFE BLACK

ART. NO. P740440



So many uses from prepping veggies to cutting rope, this jackknife is the perfect backpacking companion.

- Compact folding knife that is equally suited to cutting and chopping as to dicing and filleting
- 10cm long food-grade 18/8 stainless steel blade
- The folding design takes up very little space in a bag and makes travel safe
- The blade locks in open position and has a blade lock when folded
- Nylon carry case included that can be attached to your belt or backpack
- Can be used as a standard pocket-knife

Related products



P740450
FieldChef
Pocket Knife
Moss



P740460
FieldChef
Pocket Knife
Blue

PREPARATION

SALT AND PEPPER MILL 2 PACK

ART. NO. P740630



Give your outdoor cooking some extra flavor with these durable salt and pepper mills.

- Set of 2 mills in 2 colors for quick reference
- Made of durable aluminum
- Easy to use with just one hand

PREPARATION

CAMPFIRE SERVING KIT

ART. NO. P740820



Prep, store, or transport food, or serve it to your crew on the four stainless steel plates which fits perfectly inside the bowl under the silicon lid.

- Made of food grade 18/8 stainless steel that doesn't impart or retain flavor
- Four plates conveniently nest together and can be stored within the bowl, and are secured with the silicon lid
- Thin construction makes for an elegant and lightweight bowl
- Use the large bowl for prepping, serving, or to store your leftovers by using the silicon lid
- Tapered shape is stackable for easier packing

PREPARATION

CAMPFIRE BOWL SMALL S.S.

ART. NO. P741550



A bowl in stainless steel, perfect for soup, stews or as a small prep bowl around camp.

- Made of food grade 18/8 stainless steel that doesn't impart or retain flavor
- Tapered shape is stackable for easier packing

PREPARATION

CAMPFIRE TONG

ART. NO. P741090



Large, lightweight and durable tongs for working around the campground fire, grill, or stove.

- Made of food-grade 18/8 stainless steel that doesn't impart or retain flavor
- Sturdy yet flexible for great control while cooking
- The cutout pattern ensures a great grip even when tongs are wet or greasy
- 10.8" (275mm) length is compact enough to bring on camping trips, while long enough to keep hands away from the flames
- Jagged and narrow tip for precise control

PREPARATION

TREK POT SET

ART. NO. P741420



These hard-anodized aluminum pots are lightweight, heat quickly and offer a durable finish that are corrosion-resistant. The Trek Pots are a perfect solution for backcountry meals. Available in two sizes or as a set.

- A set of one 1-litre and one 0.6-litre hard-anodized aluminum pots that conducts heat efficiently and effectively
- Ceramic nonstick-coating for easy cooking
- Spiral pattern on pot base ensures optimum heat transfer and adds additional grip on stove pot supports
- Frying pan in hard-anodized aluminum and nonstick-coating works both as a skillet or as lid for the 1-liter pot
- Lightweight plastic lid for the 0.6-liter pot comes with silicon handle and doubles as a strainer
- 3 adjustable and removable handles allow you to cook or transport pots with ease
- Comes with a mesh storage bag
- Nests together tightly for rattle-free packing
- Invented in Sweden
- Gas and stove NOT included

TREK POT UL 0.8L

ART. NO. P745250



Trek Pot UL 0.8 L – A minimalist and ultralight pot. This pot is made from hard-anodized aluminum and is 30% thinner than other models in the Trek Pot series, making it incredibly lightweight at just 120 grams. The lid features an integrated strainer and a practical pour spout. The silicone handle on the lid folds flat against the pot and provides a secure grip when pouring. The stainless steel handles are lightweight in design and rubber-coated for an excellent grip. When folded, the pot has a sleek, minimalist profile. It's the perfect companion to the Primus Micron Stove III and fits a 100-gram gas canister inside. A convenient nylon storage bag is included for easy transport.

- A minimalist and ultralight pot
- Hard-anodized aluminum pot conducts heat efficiently
- 30% more lightweight compared to other Trek pots
- Weighs only 120 grams
- Comes with a nylon storage bag
- Invented in Sweden
- Gas and stove NOT included



DRINKWARE



DRINK

TRAILBREAK LUNCH JUG 550 BLACK

ART. NO. P737944



A great lunch transport solution that keeps salads cold or your pasta hot.

- Made of food grade 18/8 stainless steel that doesn't impart or retain flavor
- Vacuum Insulated with double-wall design keeps your food hot or cold
- Powder coated surface offers excellent grip even while wearing gloves
- Tapered design for easier handling
- Large mouth opening is easy to fill and clean
- Available in 2 sizes
- Invented in Sweden

Related products



P737948
TrailBreak
Lunch jug 550
Barn Red

DRINK

TRAILBREAK LUNCH JUG 400 BLACK

ART. NO. P737943



A great lunch transport solution that keeps salads cold or your pasta hot.

- Made of food grade 18/8 stainless steel that doesn't impart or retain flavor
- Vacuum Insulated with double-wall design keeps your food hot or cold
- Powder coated surface offers excellent grip even while wearing gloves
- Tapered design for easier handling
- Large mouth opening is easy to fill and clean
- Available in 2 sizes
- Invented in Sweden

Related products



P737947
TrailBreak
Lunch jug 400
Barn Red

DRINK

TRAILBREAK EX COAL 1.0L

ART. NO. P737952



An expedition vacuum bottle with a silicone sleeve that protects fingers and hands from freezing during cold weather adventures.

- Made of food grade 18/8 stainless steel that doesn't impart or retain flavor
- Vacuum Insulated with double-wall design keeps your drink hot or cold
- Lid doubles as a mug ensuring you always have a cup handy
- Silicon sleeve protects your fingers in wet or cold conditions
- Drinking stopper opens and closes with a slight turn
- Additional standard stopper for optimum heat retention included
- Tapered design for easier handling
- Large mouth opening is easy to fill and clean
- Available in 2 sizes
- Invented in Sweden

Related products



P737951
TrailBreak EX
Coal 0.75L

DRINK

TRAILBREAK EX COAL 0.75L

ART. NO. P737951



An expedition vacuum bottle with a silicone sleeve that protects fingers and hands from freezing during cold weather adventures.

- Made of food grade 18/8 stainless steel that doesn't impart or retain flavor
- Vacuum Insulated with double-wall design keeps your drink hot or cold
- Lid doubles as a mug ensuring you always have a cup handy
- Silicon sleeve protects your fingers in wet or cold conditions
- Drinking stopper opens and closes with a slight turn
- Additional standard stopper for optimum heat retention included
- Tapered design for easier handling
- Large mouth opening is easy to fill and clean
- Available in 2 sizes
- Invented in Sweden

Related products



P737952
TrailBreak EX
Coal 1.0L

DRINK

TRAILBOTTLE 1.0L TRITAN BLACK

ART. NO. P740120



A classic water bottle that is at home on daily walks, weekend excursions, or extended backpacking trips.

- Transparent Tritan® doesn't impart or retain flavor
- Tapered design for easier handling also slides into car cup holders or a backpack side pockets
- Lid loop connects the lid to the bottle so you don't lose it and allows you to attach the bottle to a backpack
- Stopper snaps onto its attachment on lid to stay out of the way while drinking
- Universal thread fits most water purifiers and filters
- Large mouth opening is easy to fill and clean
- Available in 2 sizes
- Invented in Sweden

Related products



P740130
TrailBottle
1.0L Tritan
Blue

DRINK

TRAILBOTTLE 0.6L TRITAN BLACK

ART. NO. P740100



A classic water bottle that is at home on daily walks, weekend excursions, or extended backpacking trips.

- Transparent Tritan® doesn't impart or retain flavor
- Tapered design for easier handling also slides into car cup holders or a backpack side pockets
- Lid loop connects the lid to the bottle so you don't lose it and allows you to attach the bottle to a backpack
- Stopper snaps onto its attachment on lid to stay out of the way while drinking
- Universal thread fits most water purifiers and filters
- Large mouth opening is easy to fill and clean
- Available in 2 sizes
- Invented in Sweden

Related products



P740110
TrailBottle
0.6L Tritan
Blue

DRINK

KLUNKEN V. BOTTLE 0.5 L ROYAL BLUE

ART. NO. P743210



A double-wall stainless steel water bottle that matches and fits into the side pocket of your backpack

- Made of food grade 18/8 stainless steel that doesn't impart or retain flavor
- Vacuum Insulated with double-wall design keeps your drink hot or cold
- Powder coated surface offers excellent grip even while wearing glove
- Screw top lid with cork finish and color-matched webbing
- Streamlined design for easier handling that slides a Kånken backpack side pocket
- Large mouth opening is easy to fill and clean

Related products

				
P742000 Klunken V. Bottle 0.5L S.S.	P742010 Klunken V. Bottle 0.5L Black	P742030 Klunken V. Bottle 0.5L Mint	P742040 Klunken V. Bottle 0.5L Frost	P742070 Klunken V. Bottle 0.5L Green

DRINK

CLASSIC LIGHT VACUUM BOTTLE 1.0L STONE GOLD

ART. NO. P743800



Always have a hot drink ready when you pack a Classic Light Vacuum Bottle with you. Engineered for optimum lighter-weight performance during outdoor experiences, this sleek drinking vessel delivers a “coffee break” on the trail.

- Engineered for minimized weight during outdoor experiences
- Made of food grade 18/8 stainless steel that doesn't impart or retain flavor
- Vacuum insulated double-wall design keeps your drink hot or cold
- Lightweight construction makes it easy to bring along on adventures
- Powder coated surface allows for an improved grip even while wearing gloves
- Stopper opens, pours, and closes with a slight twist, keeping beverages the intended temperature for even longer
- Streamlined design easily slides into water-bottle pockets and cup holders?
- Dishwasher safe
- Available in multiple sizes and colors

Related products

				
P743790	P743640	P743630	P743620	P743610
Classic Light Vacuum Bottle 1.0L Pale Peach	Classic Light Vacuum Bottle 1.0L Olive Drab Green	Classic Light Vacuum Bottle 1.0L Summit Blue	Classic Light Vacuum Bottle 1.0L Stainless Steel	Classic Light Vacuum Bottle 1.0L Black

CLASSIC LIGHT VACUUM BOTTLE 0.75L OLIVE DRAB GREEN

ART. NO. P743600



Always have a hot drink ready when you pack a Classic Light Vacuum Bottle with you. Engineered for optimum lighter-weight performance during outdoor experiences, this sleek drinking vessel delivers a “coffee break” on the trail.

- Engineered for minimized weight during outdoor experiences
- Made of food grade 18/8 stainless steel that doesn't impart or retain flavor
- Vacuum insulated double-wall design keeps your drink hot or cold
- Lightweight construction makes it easy to bring along on adventures
- Powder coated surface allows for an improved grip even while wearing gloves
- Stopper opens, pours, and closes with a slight twist, keeping beverages the intended temperature for even longer
- Streamlined design easily slides into water-bottle pockets and cup holders
- Dishwasher safe
- Available in multiple sizes and colors

Related products

				
P743570	P743580	P743590	P743770	P743780
Classic Light Vacuum Bottle 0.75L Black	Classic Light Vacuum Bottle 0.75L Stainless Steel	Classic Light Vacuum Bottle 0.75L Summit Blue	Classic Light Vacuum Bottle 0.75L Pale Peach	Classic Light Vacuum Bottle 0.75L Stone Gold

CLASSIC LIGHT VACUUM BOTTLE 0.5L PALE PEACH

ART. NO. P743750



Always have a hot drink ready when you pack a Classic Light Vacuum Bottle with you. Engineered for optimum lighter-weight performance during outdoor experiences, this sleek drinking vessel delivers a “coffee break” on the trail.

- Engineered for minimized weight during outdoor experiences
- Made of food grade 18/8 stainless steel that doesn't impart or retain flavor
- Vacuum insulated double-wall design keeps your drink hot or cold
- Lightweight construction makes it easy to bring along on adventures
- Powder coated surface allows for an improved grip even while wearing gloves
- Stopper opens, pours, and closes with a slight twist, keeping beverages the intended temperature for even longer
- Streamlined design easily slides into water-bottle pockets and cup holders?
- Dishwasher safe
- Available in multiple sizes and colors

Related products

				
P743530	P743540	P743550	P743560	P743760
Classic Light Vacuum Bottle 0.5L Black	Classic Light Vacuum Bottle 0.5L Stainless Steel	Classic Light Vacuum Bottle 0.5L Summit Blue	Classic Light Vacuum Bottle 0.5L Olive Drab Green	Classic Light Vacuum Bottle 0.5L Stone Gold

DRINK

CLASSIC LIGHT VACUUM BOTTLE 0.35L BLACK

ART. NO. P743490



Always have a hot drink ready when you pack a Classic Light Vacuum Bottle with you. Engineered for optimum lighter-weight performance during outdoor experiences, this sleek drinking vessel delivers a “coffee break” on the trail.

- Engineered for minimized weight during outdoor experiences
- Made of food grade 18/8 stainless steel that doesn't impart or retain flavor
- Vacuum insulated double-wall design keeps your drink hot or cold
- Lightweight construction makes it easy to bring along on adventures
- Powder coated surface allows for an improved grip even while wearing gloves
- Stopper opens, pours, and closes with a slight twist, keeping beverages the intended temperature for even longer
- Streamlined design easily slides into water-bottle pockets and cup holders?
- Dishwasher safe
- Available in multiple sizes and colors

Related products

				
P743500	P743510	P743520	P743730	P743740
Classic Light Vacuum Bottle 0.35L Stainless Steel	Classic Light Vacuum Bottle 0.35L Summit Blue	Classic Light Vacuum Bottle 0.35L Olive Drab Green	Classic Light Vacuum Bottle 0.35L Pale Peach	Classic Light Vacuum Bottle 0.35L Stone Gold

DRINK

SLURKEN VACUUM MUG 0.4 OX RED

ART. NO. P742710



The Slurken Vacuum Mug is a perfect on-the-go vacuum bottle developed for everyday situations.

- Made of food grade 18/8 stainless steel that doesn't impart or retain flavor
- Vacuum insulated double-wall design keeps your drink hot or cold
- Powder coated surface offers excellent grip even while wearing gloves
- Drinking lid opens and closes with a slight turn
- Streamlined design for easier handling and a unique look
- Large mouth opening is easy to fill and clean

Related products



P742700
Slurken
Vacuum mug
0.4 Mint
Green



P742690
Slurken
Vacuum mug
0.4 S.S.



P742680
Slurken
Vacuum mug
0.4 Black

DRINK

SLURKEN VACUUM MUG 0.3 BLACK

ART. NO. P742640



The Slurken Vacuum Mug is a perfect on-the-go vacuum bottle developed for everyday situations.

- Made of food grade 18/8 stainless steel that doesn't impart or retain flavor
- Vacuum insulated double-wall design keeps your drink hot or cold
- Powder coated surface offers excellent grip even while wearing gloves
- Drinking lid opens and closes with a slight turn
- Streamlined design for easier handling and a unique look
- Large mouth opening is easy to fill and clean

Related products



P742650
Slurken
Vacuum mug
0.3 S.S.



P742660
Slurken
Vacuum mug
0.3 Mint
Green



P742670
Slurken
Vacuum mug
0.3 Ox Red



P743250
Slurken
Vacuum mug
0.3 Royal Blue

DRINK

KOPPEN MUG 0.3 MINT GREEN

ART. NO. P742780



No matter where your adventures take you, the Koppen Mug keeps your drink hot longer.

- Made of food grade 18/8 stainless steel that doesn't impart or retain flavor
- Double-wall design keeps your drink hot or cold
- Powder coated surface offers excellent grip even while wearing gloves
- Stainless steel lid keeps the beverage in place
- Streamlined design for easier handling and a unique look
- Large mouth opening is easy to fill and clean
- Available in multiple colors and two sizes

Related products

DRINK

PREPPEN VACUUM JUG MINT GREEN

ART. NO. P742860



The Preppen Vacuum Jug makes any food break a breeze. Fill it with a soup, spicy noodles, or some gazpacho and your meal is always ready to be served.

- Made of food grade 18/8 stainless steel that doesn't impart or retain flavor
- Vacuum insulated double-wall design keeps your food hot or cold
- Powder coated surface offers excellent grip even while wearing gloves
- Lid opens and closes with a slight turn
- Streamlined design for easier handling and a unique look
- Large mouth opening is easy to fill and clean

Related products



P742850
Preppen
Vacuum jug
S.S.



P742870
Preppen
Vacuum jug
Ox Red



P742840
Preppen
Vacuum jug
Black

DRINK

4-SEASON MUG 0.3L

ART. NO. P732260



A double-walled traditional coffee mug that travels from your house to the campground.

- Made of food grade 18/8 stainless steel that doesn't impart or retain flavor
- Double-wall design keeps your drink hot or cold
- Traditional coffee mug silhouette
- Large mouth opening is easy to fill and clean
- Available in 2 sizes

Related products



P732250
4-Season
Mug 0.2L

DRINK

4-SEASON MUG 0.2L

ART. NO. P732250



A double-walled traditional coffee mug that travels from your house to the campground.

- Made of food grade 18/8 stainless steel that doesn't impart or retain flavor
- Double-wall design keeps your drink hot or cold
- Traditional coffee mug silhouette
- Large mouth opening is easy to fill and clean
- Available in 2 sizes

Related products



P732260
4-Season
Mug 0.3L

DRINK

FOOD VACUUM BOTTLE 1.5L

ART. NO. P732792



Bring lunch with you with this double walled vacuum insulated container.

- Vacuum Insulated with double-wall design keeps your food hot or cold
- Made of food grade 18/8 stainless steel that doesn't impart or retain flavor
- Lid doubles as a mug or small bowl ensuring you always have a way to eat or drink
- Powder coated surface offers excellent grip even while wearing gloves
- Large mouth opening is easy to fill and clean
- Available in 2 sizes
- Invented in Sweden

Related products



P732782
Food Vacuum
Bottle 1.2L

DRINK

FOOD VACUUM BOTTLE 1.2L

ART. NO. P732782



Bring lunch with you with this double walled vacuum insulated container.

- Vacuum Insulated with double-wall design keeps your food hot or cold
- Made of food grade 18/8 stainless steel that doesn't impart or retain flavor
- Lid doubles as a mug or small bowl ensuring you always have a way to eat or drink
- Powder coated surface offers excellent grip even while wearing gloves
- Large mouth opening is easy to fill and clean
- Available in 2 sizes
- Invented in Sweden

DRINK

STOPPER FOR 732782,92

ART. NO. P733370



- Stopper for food vacuum bottle 1,2L and 1,5L.

DRINK

STOPPER FOR VACUUM BOTTLES

ART. NO. P738280



DRINK

CUP CLASSIC LIGHT S.S 0.75L & 1.0L

ART. NO. P738310



DRINK

CUP FOR FOOD VACUUM BOTTLE

ART. NO. P734280



- For food vacuum bottle 1.2 L, 1.5 L

DRINK

TRAILBREAK VACUUM MUG 0.35L BLACK

ART. NO. P737902



A traditional travel coffee mug made to handle wherever your life takes you.

- Made of food grade 18/8 stainless steel that doesn't impart or retain flavor
- Vacuum Insulated with double-wall design keeps your drink hot or cold
- Powder coated surface (black only) offers excellent grip even while wearing gloves
- Drinking stopper opens and closes with a slight turn
- Tapered design for easier handling also slides into car cup holders

Related products



P737903
TrailBreak
Vacuum Mug
0.35L S.S.

DRINK

KÅSA MUG S.S.

ART. NO. P741510



A double-walled small mug that travels from city coffee shop to backcountry streams with ease.

- Made of food grade 18/8 stainless steel that doesn't impart or retain flavor
- Double-wall design keeps your drink hot or cold
- Large mouth opening is easy to fill and clean

DRINK

DRINKING GLASS S.S.

ART. NO. P741520



An all-use drinking glass in stainless steel, great for lemonade for the kids or a cocktail for mom and dad while camping or floating down the river.

- Made of food grade 18/8 stainless steel that doesn't impart or retain flavor
- Tapered design for easier packing
- Large mouth opening is easy to fill and clean

Related products



P738014
CampFire Pint
S.S.

DRINK

KOPPEN TREKKING MUG 0.3L STAINLESS STEEL

ART. NO. P743650



No matter where your adventures take you, the Koppem Mug keeps your drink hot longer.

- Foldable stainless steel handle for easier packing
- Double-wall design keeps your drink hot or cold
- Powder coated surface offers excellent grip even while wearing gloves
- BPA free plastic lid keeps the beverage in place
- Streamlined design for easier handling and a unique look
- Large mouth opening is easy to fill and clean

DRINK

KLUNKEN LID BLACK

ART. NO. P742890



- Lid for Primus Klunken bottles.

DRINK

QUICK STOPPER FOR VACUUM BOTTLES

ART. NO. P734240



- Click close stopper for fits all standard Vacuum Bottles: 0.35, 0.5, 0.75, 1 L.

DRINK

CUP FOR V. BOTTLES 0.35L

ART. NO. P734260



- For vacuum bottle 0.35 L.

DRINK

CUP FOR V. BOTTLES 0.5L

ART. NO. P734265



- For Vacuum Bottle 0,5 L

DRINK

- For vacuum bottle 0.75 L, 1 L

CUP FOR V. BOTTLES 0.75L & 1.0L

ART. NO. P734270





EAT



EAT

CAMPFIRE PLATE S/S

ART. NO. P738011



A lightweight, durable and everlasting plate makes outdoor eating more relaxing.

- Made of food grade 18/8 stainless steel that doesn't impart or retain flavor
- Thin construction makes for an elegant and lightweight plate
- Tapered shape is stackable for easier packing

EAT

LONG HANDLE SPOON ALU

ART. NO. P743480



The extended handle on this long-handled spoon is the perfect utensil when cooking on a backpacking trip.

- Hard-anodized aluminum eating spoon
- Extended handle ensures that fingers are safely away from boiling liquids or enable you to easily get everything out of the freeze-dried food bag
- Spoon-handle angle ensures easier eating
- 178mm (7.5") handle
- Dishwasher safe

EAT

LEISURE CUTLERY 24PC DISPLAY

ART. NO. P735440



The sustainable choice for the environmentally-conscious who want to ditch single use utensils.

- Display case with 24 individual sets
- 18/8 stainless steel including knife, fork and spoon
- Colorful silicone wrap packs up set tight and compact to keep everything one place
- Perfect set for the office, school, or your backpack
- Dishwasher safe

LEISURE CUTLERY CONCRETE GREY

ART. NO. P735445



The sustainable choice for the environmentally-conscious who want to ditch single use utensils.

- 18/8 stainless steel including knife, fork and spoon
- Colorful silicone wrap packs up set tight and compact to keep everything one place
- Perfect set for the office, school, or your backpack
- Dishwasher safe

Related products



P735441
Leisure
Cutlery Leaf
Green



P735446
Leisure
Cutlery Deep
Blue



P735442
Leisure
Cutlery Pale
Blue



P735443
Leisure
Cutlery
Salmon Pink



P735444
Leisure
Cutlery Melon
Pink



P738017
CampFire
Cutlery Set

TRAILSPORK TRITAN BLACK

ART. NO. P740480



The only utensil needed for ultralight backcountry adventures, a spoon, fork and cutlery all-in-one.

- BPA free plastic is lightweight
- Shape of the head allows it to be used as a spoon or a fork, while the handle can be used as a butter knife
- Perfect all-in-one utensil for the office, school, or your backpack
- Dishwasher safe

EAT

TRAILSPORK ALU

ART. NO. P740530



The only utensil needed for ultralight backcountry adventures, a durable spoon, fork and cutlery all-in-one.

- Aluminum is lightweight and durable
- Shape of the head allows it to be used as a spoon or a fork, while the handle can be used as a butter knife
- Perfect all-in-one utensil for the office, school, or your backpack
- Dishwasher safe

EAT

TRAILSPORK TI

ART. NO. P740540



The only utensil needed for ultralight backcountry adventures, a spoon, fork and cutlery all-in-one.

- Titanium is lightweight and durable
- Shape of the head allows it to be used as a spoon or a fork, while the handle can be used as a butter knife
- Perfect all-in-one utensil for the office, school, or your
- Dishwasher safe

EAT

TRAILCUTLERY ALU

ART. NO. P740550



A lightweight utensil set for trekking trips when you want a durable separate fork, spoon, and knife.

- Aluminum set including knife, fork, and spoon
- Perfect set for the office, school, or your backpack

EAT

LIGHTWEIGHT TRAILCUTLERY BLACK

ART. NO. P740580



An ultralightweight utensil set for trekking trips when you want a separate fork, spoon, and knife.

- Plastic BPA free Tritan® set including knife, fork, and spoon
- Ultralight set of utensils
- Available in multiple colors
- Dishwasher safe

EAT

FOLDING SPORK BLACK

ART. NO. P740640



Lightweight and small, this folding spoon and fork combo provides the best of both utensils when out in the wilderness.

- Plastic spoon on one side and fork on the other
- Folds in half to take up less room when packing
- Dishwasher safe
- Available in multiple colors

Related products



P740650
Folding Spork
Red

EAT

FOLDING SPORK RED

ART. NO. P740650



Lightweight and small, this folding spoon and fork combo provides the best of both utensils when out in the wilderness.

- Plastic spoon on one side and fork on the other
- Folds in half to take up less room when packing
- Dishwasher safe
- Available in multiple colors

EAT

CAMPFIRE CHOPSTICKS

ART. NO. P740970



Always have a set of chopsticks with you because some meals are best cooked or eaten with them.

- Made from bulletwood and brass
- Two detachable parts to make packing and storing easy
- Cotton storage bag included

EAT

CAMPFIRE CUTLERY SET

ART. NO. P738017



Lightweight set of 18/8 stainless steel utensils that won't snap or break.

- 18/8 stainless steel including knife, fork and spoon
- Leather sleeve packs up set tight and compact to keep everything one place
- Perfect set for the office, school, or your backpack
- Handles cut out to save weight
- Dishwasher safe



CAMPSITE



CAMP

COOLER

ART. NO. P740740



Perfect for smaller adventures when you want something cold stowed in a backpack.

- Keep food or beverages cold
- The roll-top opening makes it easy to seal the bag tight and doubles as a handle
- Outer nylon fabric is rugged and durable
- Buckle has an integrated bottle
- The 10L bag easily carries food for short adventures, while it's still small enough to conveniently be stowed away during transport
- PU-coated inside is easy-to-clean

CAMP

COOLER BACKPACK

ART. NO. P740750



The perfect companion to stay cool during any outdoor adventure.

- Insulated backpack for all your favorite camping food
- Roll-top system makes it easy to close and open, while a buckle (with a handy integrated bottle-opener) secures the content in the bag
- Outer nylon fabric is rugged and durable
- Small external pocket fits kitchen accessories or holds bottle caps
- The 22L pack easily carries food for multiple friends, and has space for 24 of longnecks or a couple of BIBs
- PU-coated inside is easy-to-clean
- EVA foam insulates the bag while providing padding for your back, making it comfortable to carry

CAMP

CAMPFIRE APRON

ART. NO. P740960



Protect your clothes from grease and soot while cooking at the campsite or in the backyard.

- Made from durable G-1000 fabric
- Two large front pockets keep any cooking accessories within reach
- Single small breast pocket for tasting spoons, pens, or a phone
- Adjustable webbing belt keeps the apron in place
- Stainless steel buckle doubles as a bottle opener

CAMP

BAG FOR ALIKA

ART. NO. P743020



Easily carry your kitchen to any basecamp. This Carry Bag transports an Alika Stove, fuel and any other small accessories you need to bring along.

- Made from water repellent and easy-to clean polyester
- Designed to easily carry or store the Alika Stove
- Holds the stove, gas and small accessories
- Hands free carry with an adjustable shoulder strap
- Buckle doubles as a bottle opener
- Invented in Sweden, made in Europe



FUEL



FUEL

SUMMER GAS CASSETTE 220G

ART. NO. P220851



Designed to power butane camp stoves and lanterns, Primus Cassette Gas will fuel your outdoor adventure.

- Contain 220g of butane.
- Self-sealing, safety valve and bayonet joint.
- Compatible with most butane-nozzle configured camping products.

SIP POWER FUEL 1.0L

ART. NO. P220995



SIP Power Fuel is an all season liquid fuel that can be filled in Primus fuel bottles. In the SIP Power Fuel, we have exchanged 40% of the fossile fuel with bio-based fuel.

- 40% bio-based fuel
- ISCC certified
- Produced in Sweden
- White gas
- Same performance as fossil based fuel

SUMMER GAS PIERCEABLE 190G

ART. NO. P221051



Pierceable Summer Gas canister is a great fuel option for hotter temperatures up to 40°C (100°F) for selected stoves.

- Fuel blend for summer month cooking needs
- Mixture of propane and butane
- Carbon dioxide-neutral camping fuel since 2015

FUEL

POWER GAS 450G L1

ART. NO. P220210



Power Gas is our most versatile fuel blend, delivering trusted power from spring to fall.

- Versatile fuel blend for the bulk of early spring to late fall cooking needs.
- Mixture of propane and isobutane.
- Available in 3 sizes.
- Carbon dioxide-neutral camping fuel since 2015.
- EN, SE, DE, RU, SL, SK, CZ, EE, PL, RO, HU, SL, BG, LT, LV, HR, SR

Related products



P220610
Power Gas
100g L1



P220710
Power Gas
230g L1

FUEL

POWER GAS 450G L2

ART. NO. P220220



Power Gas is our most versatile fuel blend, delivering trusted power from spring to fall.

- Versatile fuel blend for use from early spring to late fall cooking needs.
- Mixture of propane and isobutane.
- Available in 3 sizes.
- Carbon dioxide-neutral camping fuel since 2015.
- EN, SE, FR, DE, NO, FI, NL, IS, ES, IT, DK, GR, PO, TR, NP

Related products



P220620
Power Gas
100g L2



P220720
Power Gas
230g L2

FUEL

POWER GAS 230G L1

ART. NO. P220710



Power Gas is our most versatile fuel blend, delivering trusted power from spring to fall.

- Versatile fuel blend for the bulk of early spring to late fall cooking needs.
- Mixture of propane and isobutane.
- Available in 3 sizes.
- Carbon dioxide-neutral camping fuel since 2015.
- CZ, EN, FR, GR, NL, PO, RU, SK, SL

Related products



P220210
Power Gas
450g L1



P220610
Power Gas
100g L1

FUEL

POWER GAS 230G L2

ART. NO. P220720



Power Gas is our most versatile fuel blend, delivering trusted power from spring to fall.

- 230 gram
- Isobutane, Propane
- EN, ES, FI, IS, IT, NO, SE

FUEL

POWER GAS 230G L3

ART. NO. P220730



Power Gas is our most versatile fuel blend, delivering trusted power from spring to fall.

- Versatile fuel blend for the bulk of early spring to late fall cooking needs.
- Mixture of propane and isobutane.
- Available in 3 sizes.
- Carbon dioxide-neutral camping fuel since 2015.
- BG, DE, HR, HU,LT, LV, PL, RO, SR

Related products



P220630
Power Gas
100g L3

FUEL

POWER GAS 100G L1

ART. NO. P220610



Power Gas is our most versatile fuel blend, delivering trusted power from spring to fall.

- Versatile fuel blend for the bulk of early spring to late fall cooking needs.
- Mixture of propane and isobutane.
- Available in 3 sizes.
- Carbon dioxide-neutral camping fuel since 2015.
- EN, FR, GR, NL, PO, RU, SK, SL, CZ

Related products



P220210
Power Gas
450g L1



P220710
Power Gas
230g L1

FUEL

POWER GAS 100G L2

ART. NO. P220620



Power Gas is our most versatile fuel blend, delivering trusted power from spring to fall.

- Versatile fuel blend for the bulk of early spring to late fall cooking needs.
- Mixture of propane and isobutane.
- Available in 3 sizes.
- Carbon dioxide-neutral camping fuel since 2015.
- EN, ES, FI, IS, IT, NO, SE

Related products



P220220
Power Gas
450g L2

FUEL

POWER GAS 100G L3

ART. NO. P220630



Power Gas is our most versatile fuel blend, delivering trusted power from spring to fall.

- 100 gram
- Isobutane, Propane
- BG, DE, HR, HU, LT, LV, PL, RO, SR

Related products



P220730
Power Gas
230g L3

FUEL

SIP POWER GAS 450G L1

ART. NO. P220280



The SIP Power Gas is our most sustainable gas with reduced CO2 footprint. For every SIP Power Canister, we purchase biogas made from food waste instead of fossil-based fuel. All components, from the steel of the canister to the fuel, are sourced in Europe. The SIP Power Gas is a true allround gas that performs in the majority of outdoor cooking solutions.

- Our most sustainable fuel option with reduced CO2 footprint
- Allround gas for spring, summer and fall
- Sourcing and filling of canisters in EU
- EN, SE, FR, NO, DE, FI, NL, DK, NP, ES, IS, IT, CZ, SK, PO

Related products



P220780
SIP Power
Gas 230g L1

FUEL

SIP POWER GAS 450G L2

ART. NO. P220282



The SIP Power Gas is our most sustainable gas with reduced CO2 footprint. For every SIP Power Canister, we purchase biogas made from food waste instead of fossil-based fuel. All components, from the steel of the canister to the fuel, are sourced in Europe. The SIP Power Gas is a true allround gas that performs in the majority of outdoor cooking solutions.

- Our most sustainable fuel option with reduced CO2 footprint
- Allround gas for spring, summer and fall
- Sourcing and filling of canisters in EU
- EN, SE, DE, RU, SL, EE, PL, RO, HU, BG, GR, LV, HR, LT, TR, SRB

Related products



P220782
SIP Power
Gas 230g L2

FUEL

SIP POWER GAS 230G L2

ART. NO. P220782



The SIP Power Gas is our most sustainable gas with reduced CO2 footprint. For every SIP Power Canister, we purchase biogas made from food waste instead of fossil-based fuel. All components, from the steel of the canister to the fuel, are sourced in Europe. The SIP Power Gas is a true allround gas that performs in the majority of outdoor cooking solutions.

- Our most sustainable fuel option with reduced CO2 footprint
- Allround gas for spring, summer and fall
- Sourcing and filling of canisters in EU
- BG, EE, HR, HU, LT, LV, PL, RO, SR

FUEL

SIP POWER GAS 230G L3

ART. NO. P220783



The SIP Power Gas is our most sustainable gas with reduced CO2 footprint. For every SIP Power Canister, we purchase biogas made from food waste instead of fossil-based fuel. All components, from the steel of the canister to the fuel, are sourced in Europe. The SIP Power Gas is a true allround gas that performs in the majority of outdoor cooking solutions.

- Our most sustainable fuel option with reduced CO2 footprint
- Allround gas for spring, summer and fall
- Sourcing and filling of canisters in EU
- RU, ES, IS, IT, SL, CZ, SK, GR, PO

FUEL

WINTER GAS 450G

ART. NO. P220271



Winter Gas is our best fuel option for cold temperatures down to -22°C (-7°F).

- Fuel blend made for cold weather cooking needs.
- Mixture of 20% propane and 80% isobutane.
- Available in 2 sizes.
- Carbon dioxide-neutral camping fuel since 2015.

Related products



P220771
Winter Gas
230g

FUEL

WINTER GAS 230G

ART. NO. P220771



Winter Gas is our best fuel option for cold temperatures down to -22°C (-7°F).

- Fuel blend made for cold weather cooking needs.
- Mixture of 20% propane and 80% isobutane.
- Available in 2 sizes.
- Carbon dioxide-neutral camping fuel since 2015.

Related products



P220271
Winter Gas
450g

FUEL

SUMMER GAS 450G

ART. NO. P220251



Summer Gas is our best fuel option for hotter temperatures up to 40°C (100°F).

- Fuel blend for summer month cooking needs.
- Mixture of propane and butane.
- Available in 2 sizes.
- Carbon dioxide-neutral camping fuel since 2015.

Related products



P220751
Summer Gas
230g

FUEL

SUMMER GAS 230G

ART. NO. P220751



Summer Gas is our best fuel option for hotter temperatures up to 40°C (100°F).

- Fuel blend for summer month cooking needs.
- Mixture of propane and butane.
- Available in 2 sizes.
- Carbon dioxide-neutral camping fuel since 2015.
- EN, SE, FR, NO, DE, FI, NL, ES, IT, DK, PL, RO, HU

Related products



P220251
Summer Gas
450g

FUEL

SIP POWER GAS 230G L1

ART. NO. P220780



The SIP Power Gas is our most sustainable gas with reduced CO2 footprint. For every SIP Power Canister, we purchase biogas made from food waste instead of fossil-based fuel. All components, from the steel of the canister to the fuel, are sourced in Europe. The SIP Power Gas is a true allround gas that performs in the majority of outdoor cooking solutions.

- Our most sustainable fuel option with reduced CO2 footprint
- Allround gas for spring, summer and fall
- Sourcing and filling of canisters in EU
- EN, SE, FR, NO, DE, FI, NL, DK

Related products



P220280
SIP Power
Gas 450g L1

FUEL

POWER FUEL 1.0L

ART. NO. P220994



Power Fuel is an all season liquid fuel that can be filled in Primus fuel bottles.

- Offers consistent heat and pressure at all temperatures.
- Heptane creates a pure and efficient combustion.

FUEL

ALLROUNDGAS 135G

ART. NO. P720062



Designed to refill numerous butane powdered accessories.

- Refillable gas for gas lighters.
- Butane gas.
- Five nozzles included.

FUEL

FUEL BOTTLE GREEN 0.6L

ART. NO. P721957



These extruded aluminum ultra-light fuel bottles can go with you to the mountain summit or on that extended overland trip across the continent.

- Extruded aluminum and lacquered inside ensures more protection.
- Standard connection threads for use with a variety of stoves.
- Available in multiple colors and sizes.
- Fuel not included.

Related products



P721967
Fuel Bottle
green 1.0L



P734127
Fuel Bottle
green 0.35L

FUEL

FUEL BOTTLE GREEN 1.0L

ART. NO. P721967



These extruded aluminum ultra-light fuel bottles can go with you to the mountain summit or on that extended overland trip across the continent.

- Extruded aluminum and lacquered inside ensures more protection.
- Standard connection threads for use with a variety of stoves.
- Available in multiple colors and sizes.
- Fuel not included.

Related products



P721957
Fuel Bottle
green 0.6L



P734127
Fuel Bottle
green 0.35L

FUEL

FUEL BOTTLE GREEN 0.35L

ART. NO. P734127



These extruded aluminum ultra-light fuel bottles can go with you to the mountain summit or on that extended overland trip across the continent.

- Extruded aluminum and lacquered inside ensures more protection.
- Standard connection threads for use with a variety of stoves.
- Available in multiple colors and sizes.
- Fuel not included.

Related products



P721967
Fuel Bottle
green 1.0L



P721957
Fuel Bottle
green 0.6L

FUEL

FUEL BOTTLE CAP CHILD PROOF

ART. NO. P734740



FUEL

FUEL BOTTLE RED 0.35L

ART. NO. P737930



Lost your cap for your Primus Fuel Bottle? No worries, we have a replacement part for it.

- Screw cap to work with all Primus Fuel Bottles.
- Childproof.

Accessories



P737932
Fuel Bottle
red 1.0L



P737931
Fuel Bottle
red 0.6L



P737930
Fuel Bottle
red 0.35L

These extruded aluminum ultra-light fuel bottles can go with you to the mountain summit or on that extended overland trip across the continent.

- Extruded aluminum and lacquered inside ensures more protection.
- Standard connection threads for use with a variety of stoves.
- Available in multiple colors and sizes.
- Fuel not included.

Related products



P737931
Fuel Bottle
red 0.6L



P737932
Fuel Bottle
red 1.0L



P737933
Fuel Bottle
red 1.5L

FUEL

FUEL BOTTLE RED 0.6L

ART. NO. P737931



These extruded aluminum ultra-light fuel bottles can go with you to the mountain summit or on that extended overland trip across the continent.

- Extruded aluminum and lacquered inside ensures more protection.
- Standard connection threads for use with a variety of stoves.
- Available in multiple colors and sizes.
- Fuel not included.

Related products



P737930
Fuel Bottle
red 0.35L



P737932
Fuel Bottle
red 1.0L



P737933
Fuel Bottle
red 1.5L

FUEL

FUEL BOTTLE RED 1.0L

ART. NO. P737932



These extruded aluminum ultra-light fuel bottles can go with you to the mountain summit or on that extended overland trip across the continent.

- Extruded aluminum and lacquered inside ensures more protection.
- Standard connection threads for use with a variety of stoves.
- Available in multiple colors and sizes.
- Fuel not included.

Related products



P737930
Fuel Bottle
red 0.35L



P737931
Fuel Bottle
red 0.6L



P737933
Fuel Bottle
red 1.5L

FUEL

FUEL BOTTLE RED 1.5L

ART. NO. P737933



These extruded aluminum ultra-light fuel bottles can go with you to the mountain summit or on that extended overland trip across the continent.

- Extruded aluminum and lacquered inside ensures more protection.
- Standard connection threads for use with a variety of stoves.
- Available in multiple colors and sizes.
- Fuel not included.

Accessories



P734740
Fuel Bottle
Cap Child
proof

Related products



P737932
Fuel Bottle
red 1.0L



P737931
Fuel Bottle
red 0.6L



P737930
Fuel Bottle
red 0.35L

FUEL

LEAK DETECTOR SPRAY

ART. NO. P888888



Perfect solution to test the seal on gas and air systems. For use on tubing, hoses.

- For testing gas leaks or air systems.
- Safe to spray on various surfaces and materials.
- Reveals the smallest leaks.
- Versatile use.

FUEL

POWER GAS 100G EMPTY

ART. NO. P220660



Power Gas is our most versatile fuel blend, delivering trusted power from spring to fall.

- Empty 100 gram gas canister for display.
- Versatile fuel blend for the bulk of early spring to late fall cooking needs.
- Mixture of propane and isobutane.
- Available in 3 sizes.
- Carbon dioxide-neutral camping fuel since 2015.

FUEL

POWER GAS 230G EMPTY

ART. NO. P220760



Power Gas is our most versatile fuel blend, delivering trusted power from spring to fall.

- Empty 230 gram gas canister for display
- Versatile fuel blend for the bulk of early spring to late fall cooking needs.
- Mixture of propane and isobutane.
- Available in 3 sizes.
- Carbon dioxide-neutral camping fuel since 2015.

FUEL

SIP POWER GAS 230G EMPTY

ART. NO. P566410



The SIP Power Gas is our most sustainable gas with reduced CO2 footprint. For every SIP Power Canister, we purchase biogas made from food waste instead of fossil-based fuel. All components, from the steel of the canister to the fuel, are sourced in Europe. The SIP Power Gas is a true allround gas that performs in the majority of outdoor cooking solutions.

- Empty 230 gram SIP gas canister for display

FUEL

POWER GAS 450G US

ART. NO. P220293



FUEL

POWER GAS 100G NA

ART. NO. P220693



FUEL

SIP POWER GAS 450G US

ART. NO. P220281



FUEL

SIP POWER GAS 230G US

ART. NO. P220781



FUEL

WINTER GAS 230G NA

ART. NO. P220773



Winter Gas is our best fuel option for cold temperatures down to -22°C (-7°F).

- Fuel blend made for cold weather cooking needs.
- Mixture of 20% propane and 80% isobutane.
- Available in 2 sizes.
- Carbon dioxide-neutral camping fuel since 2015.

FUEL

FUEL BOTTLE 0.35L US

ART. NO. P737926



These extruded aluminum ultra-light fuel bottles can go with you to the mountain summit or on that extended motocross trip across the continent.

- Extruded aluminum and lacquered inside ensures more protection.
- Standard connection threads for use with a variety of stoves.
- Available in multiple colors and sizes.
- Fuel not included.

FUEL

FUEL BOTTLE 0.6L US

ART. NO. P737927



These extruded aluminum ultra-light fuel bottles can go with you to the mountain summit or on that extended overland trip across the continent.

- Extruded aluminum and lacquered inside ensures more protection.
- Standard connection threads for use with a variety of stoves.
- Available in multiple colors and sizes.
- Fuel not included.

FUEL

FUEL BOTTLE 1.0L US

ART. NO. P737928



These extruded aluminum ultra-light fuel bottles can go with you to the mountain summit or on that extended overland trip across the continent.

- Extruded aluminum and lacquered inside ensures more protection.
- Standard connection threads for use with a variety of stoves.
- Available in multiple colors and sizes.
- Fuel not included.

FUEL

FUEL BOTTLE 1.5L US

ART. NO. P737929



These extruded aluminum ultra-light fuel bottles can go with you to the mountain summit or on that extended overland trip across the continent.

- Extruded aluminum and lacquered inside ensures more protection.
- Standard connection threads for use with a variety of stoves.
- Available in multiple colors and sizes.
- Fuel not included.



SPAREPARTS



LOKE

ART. NO. P233801



Primus's infrared heater has a high output and can maintain a comfortable temperature for a long time. Its practical design allows you to use the same gas cylinder you use with your camping stove. The output can be continuously adjusted from 0 to 2500 W. Loke fits Primus and Campingaz refillable gas cylinders.

- Gas is not included.

CAMPFIRE GRIDDLE PLATE

ART. NO. P738018



Turn almost any camp stove into a grill with this small and convenient non-stick griddle plate.

- A high-quality, compact, portable, and lightweight cooking griddle made from die casted aluminum
- Can be combined with almost any stove/burner
- Non-stick surface serves convenient grilling and easy cleaning
- Designed to drain fat from the food and provide a grilled appearance
- Foldable handle for easy and secure transport in included storage bag
- Invented in Sweden

FIRESTARTER

ART. NO. P310020



Easily start a campfire anywhere and in any weather with this powerful blow torch.

- Easily start a campfire anywhere and in any weather with this powerful blow torch.
- High combustion rate makes for a more environmentally friendly fire lighting method
- Torch emits 7500 BTU
- Torch can be used upside down
- Can be used in extreme weather conditions
- Piezo ignition, no lighter required
- Works with all Primus Gas canisters, Gas NOT included
- Invented in Sweden

LABOGAS

ART. NO. P321201



GRAVITY MULTIFUEL KIT

ART. NO. P737380



Gravity Multifuel Kit transforms your gas stove to a multifuel stove. This kit is upgradesthe new Gravity EF to function with liquid fuel, including naphtha fuel and lead-free petrol, and, in case of emergencies, even kerosene. The kit contains has a 0.6-litre fuel bottle, ErgoPump, a multi-tool with a cleaning needle, fuel cup and jet nipples. A practical storage bag is included.

SPIDER MULTIFUEL KIT

ART. NO. P737500



This Multifuel Kit transforms your Spider Stove Set or Express Sprider Stove to a multifuel stove. This kit is compatible with newer Spider gas stoves purchased within the last year (from 2013). This upgrade gives you the option of using liquid fuel including, naphtha fuel and lead-free petrol, and, in case of emergencies, even kerosene. The kit contains a 0.35-litre fuel bottle, an ErgoPump, a multi-tool with a cleaning needle and jet nipples. A practical storage bag is included.

OMNILITE TI SILENCER

ART. NO. P737937



Attach this small accessory and listen to the undisturbed sounds of the wilderness, even while cooking! When using LP-gas or white gas, OmniLite Ti can be fitted with this silencer that transforms it into a silent stove. The silencer is not suitable when burning diesel, kerosene/paraffin or aviation fuel.

STOVEPAW

ART. NO. P721230



- Base plate for Primus stoves.
- Essential accessory for hose-mounted stoves when used on soft or uneven surfaces like snow, sand, or gravel.
- Increases the footprint of the stove, thus making it stand more stable and safe.
- Made of titanium, making the StovePaw Ti light and durable.
- Clip into special slots in the plate, attaching them securely.
- Fits Primus OmniFuel, MultiFuel, OmniLite Ti, EasyFuel, Express Spider, and some other stoves with three feet.

PIEZO IGNITER

ART. NO. P741460



Start a fire or light your stove in all weather conditions.

- Water-resistant and works in wet conditions – even rain and snow
- A spark with a simple click of a button
- Designed for use even when wearing gloves
- Invented in Sweden

CANISTER STAND

ART. NO. P741560



- Canister Stand
- Made from 94 % bio-based plastic and fiber glass blend, produced locally in Sweden
- Increases stability for stoves that screw directly onto the gas canister
- Compatible with all Primus gas canisters (along with most other brands)

WINDSCREEN AND HEAT REFLECTOR SET

ART. NO. P721720



- Windscreen and Heat Reflector Set increases heat output and shortens cooking time.
- Focuses heat on the pot and preheating coil.
- Fits Primus OmniFuel, MultiFuel, Gravity, VariFuel, EasyFuel, and ExpressSpider stoves.

SUSPENSION KIT FOR 3GRID STOVES

ART. NO. P721220



- Suspension Kit
- The wires hold the stove and LP gas cartridge or fuel bottle together
- Separated at the top to easily allow access for pots and pans.
- Fits all of Primus stoves with three pot supports
- Available in two versions for stoves with three or four legs.

SUSPENSION KIT FOR 4GRID STOVES

ART. NO. P733320



- Suspension Kit that holds the stove and LP gas cartridge or fuel bottle together
- Fits all of Primus stoves with three pot supports
- Available in two versions

PRIMETECH INSULATION BAG 2.3L

ART. NO. P745260



- padded/insulated storage bag

Related products



P745270
Primetech
Insulation Bag
1.3L

PRIMETECH INSULATION BAG 1.3L

ART. NO. P745270



- padded/insulated storage bag

Related products



P745260
Primetech
Insulation Bag
2.3L

POWERLIGHTER III BLACK

ART. NO. P733307



A traditional lighter that can start a fire or stove in any weather condition.

- Water-resistant and works in wet conditions – even rain and snow
- Small cord for carrying convenience
- Narrow flame emits a temperature of 1300°C
- Invented in Sweden
- Available in multiple colors

Related products



P733308
PowerLighter
III Red

POWERLIGHTER III RED

ART. NO. P733308



A traditional lighter that can start a fire or stove in any weather condition.

- Water-resistant and works in wet conditions – even rain and snow
- Small cord for carrying convenience
- Narrow flame emits a temperature of 1300°C
- Invented in Sweden
- Available in multiple colors

FILLING ADAPTOR

ART. NO. P733870



The Filling Adaptor can be used to refill Primus PowerLighter and other refillable lighters. This product can easily be connected to the Primus PowerGas single use gas cartridges.

BAG FOR TUPIKE & KINJIA

ART. NO. P741190



Easily carry your kitchen to any basecamp. This Carry Bag transports a Tupike or Kinjia Stove, fuel and any other small accessories you need to bring along.

- Made from water repellent and easy-to clean polyester
- Designed to easily carry or store the Tupike or Kinjia Stove
- Holds the stove, gas and small accessories
- Hands free carry with an adjustable shoulder strap
- Buckle doubles as a bottle opener
- Invented in Sweden, made in Europe

- Piezo for Mimer Stove / Classic Trail

PIEZO IGNITER W. HOLDER FOR 2243

ART. NO. P720120



REGULATOR 30MBAR P.O.L 8MM 1.5 KG

ART. NO. P720270



ACCESSORIES & SPARE PARTS

REGULATOR 30MBAR PRIMUS 8MM

ART. NO. P720530



ACCESSORIES & SPARE PARTS

REGULATOR 30MBAR M16 X1,5

ART. NO. P720590



LANTERN GLASS FOR 2172, 2179 ,2269

ART. NO. P720630



SERVICE KIT FOR 3278,328883

ART. NO. P721290



- Service Kit for VariFuel and Himalayan MultiFuel

PRIMING PAD FOR 3278,88 2PC

ART. NO. P721450



- Priming pad for VariFuel / Himalayan MultiFuel Stoves, comes in 2-pack.

SERVICE KIT FOR ALL FUEL PUMPS

ART. NO. P721460



- Service Kit for ErgoPump
- Includes leather packing, O-ring, silicone grease and parts for valve (brass cone, o-ring, spring and lid)

LANTERN GLASS FOR 2245, 3230

ART. NO. P721490



CLEANING WIRE FOR 3278,3288 5PC

ART. NO. P730610

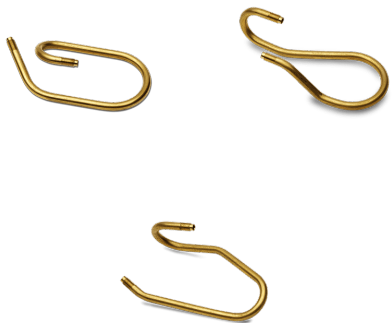

- Cleaning wire for preheating tube for VariFuel and Himalayan MultiFuel

ACCESSORIES & SPARE PARTS

BRASS NUT FOR 3277,78,88 5PC

ART. NO. P730620



ACCESSORIES & SPARE PARTS

WASHER FOR 3277,78,88 5PC

ART. NO. P730630



- Disc for the centre screw of EasyFuel, EasyFuel Duo, VariFuel and Himalayan MultiFuel

GASKET FOR 3277,78,88 5PC

ART. NO. P730640



- Disc for under the burner of EasyFuel, EasyFuel Duo, VariFuel and Himalayan MultiFuel

JET NIPPLE 0.28 FOR 3278,88,89 5PC

ART. NO. P730670



- Jet nipple for EasyFuel, EasyFuel Duo, VariFuel, and Himalayan MultiFuel

- Flame spreader for VariFuel and Himalayan MultiFuel

FLAME SPREADER 3278-88 5PC

ART. NO. P730680



LEATHER GASKET FOR ALL PUMPS 5PC

ART. NO. P730690



LEATHER GREASE FOR ALL PUMPS 5PC

ART. NO. P730710



O-RING NON-RETURN VALVE 5PC

ART. NO. P730740



- O-ring for back valve for all fuel pumps

ACCESSORIES & SPARE PARTS

SPRING NON-RETURN VALVE 5PC

ART. NO. P730750



ACCESSORIES & SPARE PARTS

TOP NON-RETURN VALVE 5PC

ART. NO. P730760



ACCESSORIES & SPARE PARTS

MANTLE (PACK OF 3) LANTERNS

ART. NO. P730800



ACCESSORIES & SPARE PARTS

PIEZO IGNITER FOR 2245

ART. NO. P730850



- Piezo for EasyLight

JET NIPPLE FOR 2077, 2089

ART. NO. P731190



JET FOR 2077 & 2089 BUTANE

ART. NO. P731210

- Jet for 2077 and 2089 Butane



ACCESSORIES & SPARE PARTS

JET NIPPLE FOR 2152/2159 2PC

ART. NO. P731430



ACCESSORIES & SPARE PARTS

GASKET FOR REGULATOR W. P.O.L-CONN.

ART. NO. P731600



SERVICE KIT FOR 328894-95,3289

ART. NO. P731770

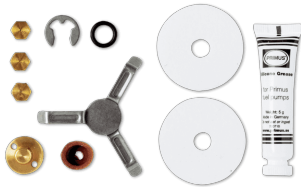

- Service Kit for OmniFuel and MultiFuel stoves made before 2016

SERVICE KIT FOR 328896,328988-89

ART. NO. P731771



- Service Kit for OmniFuel II och MultiFuel III made after 2016

PRIMING PAD FOR 3219,88,89 2PC

ART. NO. P731780



- Priming pad for OmniFuel, MultiFuel and OmniLite Ti, comes in 2-pack.

JET NIPPLE 0.45 FOR 3288,89 5PC

ART. NO. P731790



- Jet nipple for Omnifuel and Multifuel

JET NIPPLE 0.37 FOR 3288,89 5PC

ART. NO. P731800



- Jet nipple for Omnifuel and Multifuel

MULTI TOOL FOR 3219,78,88,89

ART. NO. P731860



- Multi tool for OmniFuel, OmniLite Ti and Multifuel

FLAME SPREADER FOR 3288,89 5PC

ART. NO. P731870

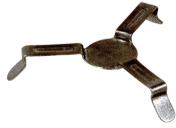

- Flame spreader for OmniFuel and MultiFuel manufactured before 2015.

FLAME SPREADER FOR 328896,328988-89

ART. NO. P731871



- Flame spreader for OmniFuel and MultiFuel manufactured after 2015

HOLDER FOR PRIMING PAD 3289 5PC

ART. NO. P731880



- Holder for priming pad on MultiFuel, OmniFuel and OmniLite Ti,
- As well as for burners on Express Spider, Kinjia, Tupike

FUEL FILTER FOR 3289 5PC

ART. NO. P731890



- Fuel filter for Ergopump 5-pack

ACCESSORIES & SPARE PARTS

SPINDLE W. O-RING FOR 3289 5PC

ART. NO. P731900



- Spindle with O-ring for Omnifuel.
- 5-pack.

ACCESSORIES & SPARE PARTS

CLEANING NEEDLE 3219,78,88,89 2PC

ART. NO. P731910



- Cleaning needle for the multitool
- 2-pack.

THREAD HANDLE FOR 3219,89 5PC

ART. NO. P731920



- Thread handle for OmniLite Ti

HOSE W. VALVE FOR 3219,77,88,89

ART. NO. P731930



- Hose with valve for OmniFuel, OmniLite Ti, MultiFuel and EasyFuel

BRASS SCREW FOR 3288,89 5PC

ART. NO. P731940



- Brass Screw for OmniFuel and MultiFuel manufactured before 2015

BRASS SCREW FOR 328896,328988-89 5PC

ART. NO. P731941



- Brass screw for OmniFuel and MultiFuel manufactured after 2015

JET NIPPLE 0.40 FOR 3277 5PC

ART. NO. P732000



- Jet nipple for EasyFuel

JET NIPPLE 0.43 FOR 3243 5PC

ART. NO. P732030



- Jet nipple 0.43 for Power Cook

JET NIPPLE 0.12 FOR 2213,45,3230 5PC

ART. NO. P732070



JET NIPPLE 0.14 FOR 2269,3240 5PC

ART. NO. P732100



- Jet nozzle for Mimer Lantern & Classic Moonlight Lantern

PIEZO IGNITER W. HOLDER FOR 3213

ART. NO. P732110



- Piezo for Express Stove and Micron Stove

STOVE BODY FOR 3277,78,88

ART. NO. P732220



- Body for EasyFuel, VariFuel and Himalayan MultiFuell

ERGOPUMP FOR 3281,88,89,3520

ART. NO. P732231



- Pump for stoves that can run on both gas and liquid fuel

ERGOPUMP FOR 3278/3280

ART. NO. P732240



- Pump with bayonet socket for VariFuel, and stoves that can only be run on liquid fuel.

O-RING FOR ALL VALVES 2PC

ART. NO. P732440



- O-ring for standard valves, comes in 2-pack

MESH BASKET FOR 2213

ART. NO. P732450



- Mesh basket for Micron Lantern

PIEZO IGNITER FOR 2213

ART. NO. P732460



- Piezo for Micron Lantern

GASKET FOR ERGOPUMP 5PC

ART. NO. P732470



- O-ring that seals between pump and fuel bottle
- 5-pack

PLASTIC BUSHING FOR ALL PUMPS 5PC

ART. NO. P732480



GENERATOR TUBE FOR 3279,80,81

ART. NO. P732840



- Generator Tube / preheating coil for Gravity

CLEANING WIRE FOR 3280-81,3284 5PC

ART. NO. P732850



JET NIPPLE 0.45 3279,81 5PC

ART. NO. P732880

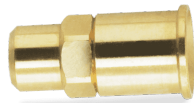

HOSE W. VALVE FOR 3279-81,3284,3510

ART. NO. P732910



- Hose with valve for Gravity, Spider Stove Set and Power Stove Set

O-RING CONNECTION VALVE ON ERGOPUMP 3278,80 5PC

ART. NO. P732930



- O-ring for the upper check valve, at the hose connection

MULTI TOOL FOR 3279,80,81

ART. NO. P732940



- Multi-tool for Gravity, Express Spider, Power stove set and Eta power

PIEZO IGNITER FOR 3270

ART. NO. P733340



- Piezo for TechnoTrail with holder

TENT H4 POLE LONG

ART. NO. P733631

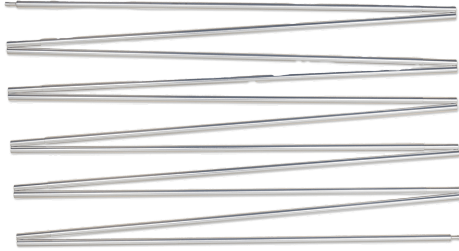

Tent pole (long/silver) for Bifrost H4.

TENT H4 POLE SHORT

ART. NO. P733651



Tent pole (short/silver) for Bifrost H4.

TENT H6 POLE LONG

ART. NO. P733661

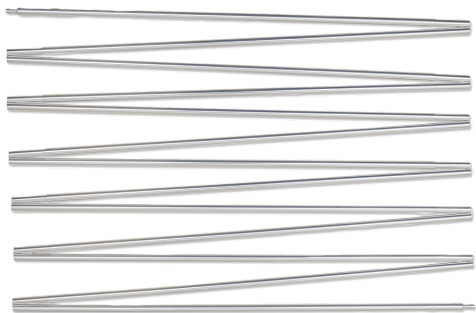

Tent pole (long/silver) for Bifrost H6.

TENT H6 POLE MEDIUM

ART. NO. P733671

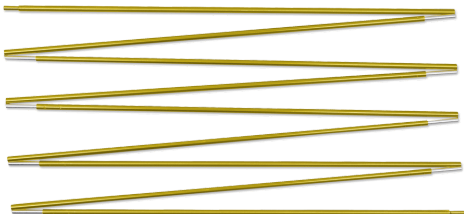

Tent pole (medium/gold) for Bifrost H6.

ACCESSORIES & SPARE PARTS

TENT H6 POLE SHORT

ART. NO. P733681



ACCESSORIES & SPARE PARTS

TENT Y6 POLE LONG

ART. NO. P733691



ACCESSORIES & SPARE PARTS

TENT Y6 POLE MEDIUM

ART. NO. P733701



ACCESSORIES & SPARE PARTS

TENT Y6 POLE SHORT

ART. NO. P733711

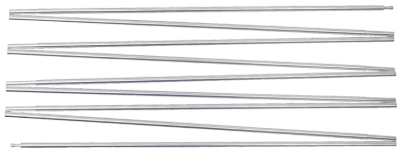

ACCESSORIES & SPARE PARTS

O-RING FOR 4043, 4069 2PC

ART. NO. P733790



ACCESSORIES & SPARE PARTS

LANTERN TOP FOR 2245

ART. NO. P733820



STOVE BODY FOR 3288,89

ART. NO. P733940



- Body for OmniFuel and MultiFuel

STOVE BODY FOR 328896,328988-89

ART. NO. P733941



- Stove body for OmniFuel II and MultiFuel II

JET NIPPLE 0.32 FOR 3510,20,3284 5PC

ART. NO. P733950

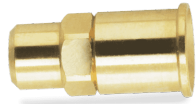

- Jet nozzle for ETA Power, Power Stove set & Express Spider

SERVICE KIT FOR 3520

ART. NO. P734150



- Service Kit for Eta Power MF

HOSE ASSY FOR 3299

ART. NO. P734170



- Hose with Regulator
- For Atle, Atle II, Atle 2B

PRIMING PAD FOR 3520,328194-96

ART. NO. P734220



- Priming pad for ETA Power, Power Stove Set and Spider Stove Set

JET NIPPLE 0.37 FOR 328194-96 5PC

ART. NO. P734300

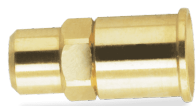

- Nozzle for Gravity MF

JET NIPPLE 0.42 FOR 3279,81 5PC

ART. NO. P734310

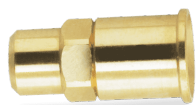

- Jet nipple 0.42 for Gravity

JET NIPPLE 0.28 FOR 3520 5PC

ART. NO. P734330

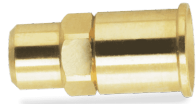

- Nozzle for ETA Power MF

SERVICE KIT FOR 328194-96

ART. NO. P734340



- Service kit for Gravity II MF

GENERATOR TUBE FOR 3510,20,40

ART. NO. P734360



- Generator tube for EtaPower Stove

GENERATOR TUBE FOR 328194-96

ART. NO. P734370



- Generator tube for Gravity II & Gravity III

PIEZO IGNITER FOR 327743,93

ART. NO. P734380



- Piezo for EasyFuel

JET NIPPLE 0.39 FOR 324417 5PC

ART. NO. P734660



- Jet nipple 0.39 for Power Cook

LANTERN GLASS FOR 221363

ART. NO. P734720



PIEZO IGNITER FOR ATLE STOVES

ART. NO. P734930



- Piezo for Alte, Older model with button

CONNECTION VALVE FOR 732230-31

ART. NO. P734960



- Swiveling Connection valve for ErgoPump

PIEZO IGNITER FOR 2269

ART. NO. P735340



- Piezo for Mimer Lantern

BURNER TOP FOR 3219

ART. NO. P737210



- Burner body to OmniLite.

JET NIPPLE 0.32 FOR 3219,88 5PC

ART. NO. P737230



- Jet nozzle for OmniLite Ti. 0.32mm for Petrol / Gasoline, 5-pack

- Jet nozzle for OmniLite Ti. 0.36mm for Gas / LPG 5-pack

JET NIPPLE 0.36 FOR 3219 5PC

ART. NO. P737240



- Stove body for OmniLite Ti

STOVE BODY FOR 3219

ART. NO. P737250



SPINDLE W. O-RING FOR 3219 5PC

ART. NO. P737260



- Spindle with O-ring for OmniLite Ti
- 5-pack

BRASS SCREW FOR 3219 5PC

ART. NO. P737270



- Brass screw for OmniLite Ti

- Service Kit for OmniLite Ti

SERVICE & MAINTENACE KIT FOR 3219

ART. NO. P737280



- Handheld Piezo with nozzle tool

PIEZO IGNITER FOR 351032

ART. NO. P737460



PIEZO IGNITER - FOR 3560

ART. NO. P737650



- Piezo for Lite, Lite + & Lite XL

GRIDS FOR 3501

ART. NO. P738023



Grids for Kinjia and Tupike Stove

PIEZO IGNITER FOR 3501

ART. NO. P738024



HOSE INCL REGULATOR FOR 3501

ART. NO. P738026



DIN COMBI FOR TUPIKE & KINJIA

ART. NO. P738036



Adapter for connecting LPG bottles with DIN Kombi connection. Fits Kinjia, Tupike & Kuchoma.

OPENFIRE PACK SACK

ART. NO. P738062



A smart choice to easily transport or store Primus Openfire Pans and firepits so soot and ash don't transfer unintentionally.

- Transports the Openfire Pans or the Kamoto Openfire Pit and any other small accessories you need to bring along
- Safely store the Kamoto or Openfire Pan when not in use and keep soot and ash packed away during travel
- Flap-top construction makes it easy to open and close, while a buckle (with a handy integrated bottle-opener) secures the bag
- Outer nylon fabric is rugged and durable
- PU-coated inside is easy-to-clean

JET NIPPLE FOR 351030-33

ART. NO. P740690



- Jet nozzle for Essential Stove set

PRIMETECH LID S 1.3L

ART. NO. P740710



- Lid in transparent Tritan®;
- Compatible for PrimeTech pot 1.3 L.
- Integrated strainer and heat-resistant silicone handles

PRIMETECH LID L 2.3L

ART. NO. P740720



- Lid in transparent Tritan®
- Compatible with PrimeTech pot 2.3 L
- Integrated strainer and heat-resistant silicone handles

HOSE W. ADAPTER P.O.L FOR KUCHOMA (440070)

ART. NO. P741120



Hose with regulator and connection for gas bottles with POL valve

ACCESSORIES & SPARE PARTS

TOOL FOR KUCHOMA & TUPIKE

ART. NO. P741130



ACCESSORIES & SPARE PARTS

GRILL GRATE FOR KUCHOMA (4400)

ART. NO. P741140



Grill grate for Kuchoma

ACCESSORIES & SPARE PARTS

BURNER FOR KUCHOMA (4400)

ART. NO. P741150



ACCESSORIES & SPARE PARTS

PIEZO IGNITER FOR KUCHOMA (4400)

ART. NO. P741160



EXTENTION HOSE FOR 3501

ART. NO. P741170



M16X1.5 ADAPTOR FOR 3501/4400 (CAMPINGAZ)

ART. NO. P741290



Adapter for connection of LPG bottles with M16x1.5 connection, Eg. CampinGaz R901, R904 & R907. Fits Kinjia, Kuchoma, Tupike, Alike and Moja.

M14X1.5 ADAPTOR FOR 3501/4400 (PRIMUS)

ART. NO. P741300



Adapter for connection of LPG bottles with M14x1.5 connection, e.g. 2012, 2006 & 2000 Fits Kinjia, Kuchoma, Alika, Moja and Tupike.

LINDAL VALVE ADAPTOR FOR 3501,4400,2202,2206,2207

ART. NO. P741310



Adapter for connecting gas containers of EN417 standard with Lindal connection, 7/16 "NS. Fits Kinjia, Kuchoma, Moja, Alika and Tupike.

P.O.L ADAPTOR FOR 3501/4400 (P/PA CANISTERS)

ART. NO. P741330



Adapter for connecting LPG bottles with P.O.L connection, e.g. PC5, PC10, P6 and P11. Fits Kinjia, Kuchoma, Aliko, Moja and Tupike.

LID FOR TRAILBOTTLE TRITAN & S.S.

ART. NO. P741470



ACCESSORIES & SPARE PARTS

MANTLE FOR LP GAS LANTERNS 3PC

ART. NO. P800901



ACCESSORIES & SPARE PARTS

LANTERN GLASS FOR 2152, 2159, 2257

ART. NO. P811006



O-RING PRIMUS CYLINDER 2PC

ART. NO. P830606



HOSE ASSY FOR 3299 US

ART. NO. P734175



LITE XL LID

ART. NO. P743980



- spare lid for LiteXL Stove

LITE PLUS LID

ART. NO. P743970



- spare lid for Lite Plus Stove

Adapter for connection of American 16.4oz Propane bottle. Fits Kinjia, Kuchoma, Alike, Moja and Tupike.

16.4 OZ ADAPTOR FOR 3501/4400 (PROPANE CANISTERS US)

ART. NO. P741320





POINT OF SALES



OTHER

STICKER LOGOTYPE - 97 X 21 MM

ART. NO. P566136

PRIMUS

OTHER

STICKER LOGOTYPE - 194 X 41 MM

ART. NO. P566137

PRIMUS

OTHER

SIP TOPOGRAPHI

ART. NO. P566430



Can be placed on table or SIP Topography podium. Canisters not included.

OTHER

Topography is not included. Only podium to have the topography standing on.

SIP TOPOGRAPHY PODIUM

ART. NO. P566440

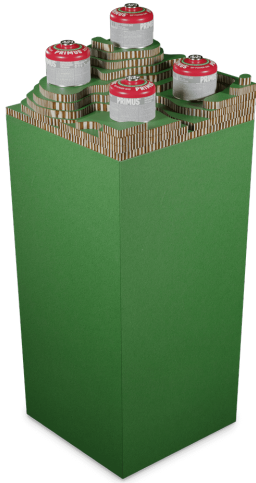

OTHER

Includes 10 Primus figure pins to attach to the cork sign.

PRIMUS LOGO SIGN CORK

ART. NO. P566520



OTHER

PRIMUS LOGO SIGN RED

ART. NO. P566530



OTHER

Birch wood card holders. Sign not included.

PRODUCT INFO CARD HOLDER

ART. NO. P566540



OTHER

STOVE STORE DISPLAY

ART. NO. P566560



Possibility for slot-wall mount. Changeable cardboard sign. Sign not included. Includes 10 Primus figure pins to attach to the cork mountain ridge.

OTHER

GAS SHELF

ART. NO. P566570

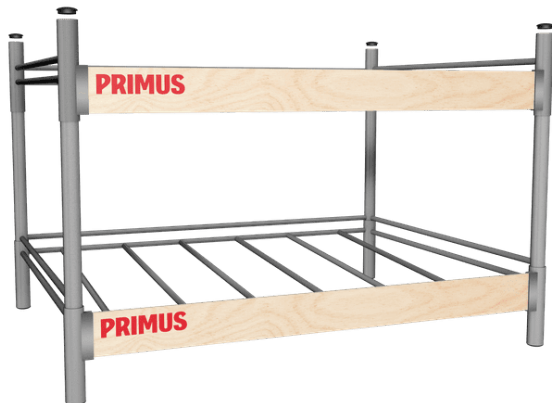

Fits for all Primus gas canister sizes. One shelf fits 24 x 100g or 18 x 230g or 12 x 450g or an according mix of all sizes. The shelves are stackable.

PRIMUS

SWEDISH OUTDOOR ENGINEERING SINCE 1892